

**S SERIES PERISTALTIC PUMP  
INSTALLATION AND MAINTENANCE MANUAL**  
.....  
**PERISTALTIC METERING PUMPS SINCE 1957**

 **WARNING**

TO BE INSTALLED AND MAINTAINED BY PROPERLY TRAINED PROFESSIONAL INSTALLER  
ONLY. READ MANUAL & LABELS FOR ALL SAFETY INFORMATION & INSTRUCTIONS.

# TABLE OF CONTENTS

<b>WARRANTY AND SERVICE POLICY</b> .....	3
<b>SAFETY INSTRUCTIONS</b> .....	
COVER, 4-6, 17, 31, 34, 37, 41, 49, 65, 67-68, 70, 72-73, 75, 78, 79, 81-85, 88-89, 94	
<b>FLOW RATE OUTPUT CHARTS</b> .....	6
<b>MATERIALS OF CONSTRUCTION</b> .....	7
<b>ACCESSORY CHECKLIST</b> .....	8
<b>GENERAL INFORMATION</b> .....	9-11
<b>CONFIGURATION</b> .....	12-28
<b>CONTROL MODES</b> .....	29-52
<b>OPERATING DISPLAY</b> .....	53-64
<b>CONNECTIONS</b> .....	65-77
<b>INSTALLATION</b> .....	78-84
<b>TROUBLESHOOTING</b> .....	85-88
<b>TUBE REPLACEMENT</b> .....	89-93
<b>CLEANING THE POINT OF INJECTION</b> .....	94-95
<b>PARTS</b> .....	96-100
<b>WALL MOUNT BRACKET MOUNTING HOLE DIMENSIONS</b> .....	101

IMS 061219

# WARRANTY AND CUSTOMER SERVICE

## LIMITED WARRANTY

Stenner Pump Company will for a period of one (1) year from the date of purchase (proof of purchase required) repair or replace – at our option – all defective parts. Stenner is not responsible for any removal or installation costs. Pump tube assemblies and rubber components are considered perishable and are not covered in this warranty. Pump tube will be replaced each time a pump is in for service, unless otherwise specified. The cost of the pump tube replacement will be the responsibility of the customer. Stenner will incur shipping costs for warranty products shipped from our factory in Jacksonville, Florida. Any tampering with major components, chemical damage, faulty wiring, weather conditions, water damage, power surges, or products not used with reasonable care and maintained in accordance with the instructions will void the warranty. Stenner limits its liability solely to the cost of the original product. We make no other warranty expressed or implied.

## RETURNS

Stenner offers a 30-day return policy on factory direct purchases. Except as otherwise provided, no merchandise will be accepted for return after 30 days from purchase. To return merchandise at any time, call Stenner at 800.683.2378 for a Return Merchandise Authorization (RMA) number. A 15% re-stocking fee will be applied. Include a copy of your invoice or packing slip with your return.

## DAMAGED OR LOST SHIPMENTS

All truck shipments: Check your order immediately upon arrival. All damage must be noted on the delivery receipt. Call Stenner Customer Service at 800.683.2378 for all shortages and damages within seven (7) days of receipt.

## SERVICE & REPAIRS

Before returning a pump for warranty or repair, remove chemical from pump tube by running water through the tube, and then run the pump dry. Following expiration of the warranty period, Stenner Pump Company will clean and overhaul any Stenner metering pump for a minimum labor charge plus necessary replacement parts and shipping. All metering pumps received for overhaul will be restored to their original condition. The customer will be charged for missing parts unless specific instructions are given. To return merchandise for repair, call Stenner at 800.683.2378 or 904.641.1666 for a Return Merchandise Authorization (RMA) number.

## DISCLAIMER

The information contained in this manual is not intended for specific application purposes. Stenner Pump Company reserves the right to make changes to prices, products, and specifications at any time without prior notice.

## TRADEMARKS

QuickPro® is a registered trademark of the Stenner Pump Company.

Santoprene® is a registered trademark of Exxon Mobil Corporation.

Versilon® is a registered trademark of Saint-Gobain Performance Plastics.

Pellethane® is a registered trademark of Lubrizol Advanced Materials, Inc.

Hastelloy® is a registered trademark of Haynes International, Inc.

AquaShield™ is a trademark of Houghton International.

# SAFETY INSTRUCTIONS

## IMPORTANT SAFETY INSTRUCTIONS

When installing and using this electrical equipment, basic safety precautions should always be followed, including the following:

## READ AND FOLLOW ALL INSTRUCTIONS

 **⚠ WARNING** Warns about hazards that **CAN** cause death, serious personal injury, or property damage if ignored.

 **⚠ WARNING** **ELECTRIC SHOCK HAZARD**

 **⚠ WARNING** **RISK OF ELECTRIC SHOCK**

Connect only to a branch circuit protected by a ground-fault circuit-interrupter (GFCI). Contact a qualified electrician if you cannot verify that the receptacle is protected by a GFCI.

 **⚠ AVERTISSEMENT** **RISQUE DE CHOC ELECTRIQUE**

Brancher seulement à un réseau électrique protégé par un DDFT. Contactez un électricien certifié si vous ne pouvez pas vérifier que la prise est protégé par un DDFT.

 **⚠ PELIGRO** **PELIGRO DE DESCARGA ELECTRICA**

Conecte a un circuito en derivación protegido por un interruptor de descarga a tierra (GFCI). Contacte a un electricista certificado si no puede verificar que su receptáculo esté protegido por dicho interruptor (GFCI).

 **⚠ WARNING** To reduce the risk of electric shock, replace damaged cord immediately. Contact the factory or an authorized service facility for repair.

 **⚠ WARNING** **DO NOT** alter the power cord or plug end. **DO NOT** use receptacle adapters.

 **⚠ WARNING** **DO NOT** use pump with a damaged or altered power cord or plug. Contact the factory or authorized service facility for repair.

 **⚠ WARNING** After installation, the power supply plug must be accessible during use.

 **⚠ WARNING** To reduce the risk of injury, do not permit children to use this product. This appliance is not to be used by persons with reduced physical, sensory or mental capabilities, or lack of experience and knowledge, unless they have been given supervision or instruction.

 **⚠ WARNING** This pump has not been investigated for use in marine areas.

 **⚠ AVERTISSEMENT** La pompe n'a pas été vérifiée et approuvée pour utilisation sur des applications de installation marine.

 **⚠ PELIGRO** Este dosificador no ha sido investigado para uso en áreas marinas.

 **⚠ WARNING** **EXPLOSION HAZARD**  
This equipment **IS NOT** explosion proof. **DO NOT** install in an explosive environment.

 **⚠ WARNING** **RISK OF CHEMICAL EXPOSURE AND OVERDOSE**  
Potential for chemical burns, fire, explosion, personal injury, or property damage. To reduce risk of exposure, the use of proper personal protective equipment is mandatory. To reduce risk of overdosing, follow proper installation methods and recommendations. Check your local codes for additional guidelines.

 **⚠ WARNING** **RISK OF FIRE HAZARD**  
**DO NOT** install or operate on any flammable surface.

 **⚠ WARNING** Pump is not recommended for installation in areas where leakage can cause personal injury or property damage.

# SAFETY INSTRUCTIONS continued

 **CAUTION** Warns about hazards that WILL or CAN cause minor personal injury or property damage if ignored.

 **CAUTION** To reduce risk of electric shock, pull plug before servicing this pump.

 **CAUTION** This pump has been evaluated for use with water only.

 **CAUTION** Non-submersible pump. Suitable for indoor and outdoor use.

 **ATTENTION** Pompe non submersible. Adaptée à une utilisation aussi bien à l'intérieur qu'à l'extérieur.

 **CUIDADO** Dosificador no sumergible. Adecuado para el uso interior y exterior.

 **CAUTION PLUMBING**

Chemical feed pump installation must always adhere to your local plumbing codes and requirements. Be sure installation does not constitute a cross connection. Check local plumbing codes for guidelines.

 **CAUTION** Electrical installation should adhere to all national and local codes. Consult licensed professional for assistance with proper electrical installation.

 **CAUTION** Pump uses a class 2 switching power supply.

## SAVE THESE INSTRUCTIONS

 **NOTICE: Indicates special instructions or general mandatory action.**

 This metering pump is portable and designed to be removable from the plumbing system without damage to the connections.

 This metering pump and its components have been tested for use with the following chemicals; Sodium Hypochlorite (10-15%), Muriatic Acid (20-22 Baume, 31.5% HCl), and Soda Ash.

 Cette a pompe de dosage et ses composants ont été testés pour utilisation avec les produits chimiques suivants; Hypochlorite de Sodium (solution de 10-15%); Acide Muriatique (20-22 Baume, 31.5% HCl); Cendre de Soude.

 Before installing or servicing the pump, read the pump manual for all safety information and complete instructions. The pump is designed for installation and service by properly trained personnel.

 No user replaceable parts inside.

 Do not install at altitudes over 2000 meters.

# FLOW RATE OUTPUT CHARTS

## 25 psi (1.7 bar) Maximum

Model	Tube	Turndown Ratio	Gallons per Day	Gallons per Hour	Ounces per Hour	Ounces per Minute	Liters per Day	Liters per Hour	Milliliters per Hour	Milliliters per Minute
<b>S3003</b>	3	100:1	0.40-40	0.017-1.67	2.13- 213	0.036-3.56	1.51-151	0.063-6.31	63.09-6309	1.05-105
<b>S3004</b>	4	100:1	0.60-60	0.025-2.50	3.20-320	0.053-5.33	2.27-227	0.095-9.46	94.64-9464	1.58-158
<b>S3005</b>	5	100:1	0.85-85	0.035-3.54	4.53-453	0.076-7.56	3.22-322	0.134-13.41	134.07-13407	2.23-223
Approximate Output @ 50/60Hz										

## 100 psi (6.9 bar) Maximum

Model	Tube	Turndown Ratio	Gallons per Day	Gallons per Hour	Ounces per Hour	Ounces per Minute	Liters per Day	Liters per Hour	Milliliters per Hour	Milliliters per Minute
<b>S3001*</b>	1	100:1	0.05-5	0.002-0.21	0.27-27	0.004-0.44	0.19-19	0.008-0.79	7.89-789	0.13-13
<b>S3002*</b>	2	100:1	0.17-17	0.007-0.71	0.91-91	0.015-1.51	0.64-64	0.027-2.68	26.81-2681	0.45-45
<b>S3007*</b>	7	100:1	0.40-40	0.017-1.67	2.13-213	0.036-3.56	1.51-151	0.063-6.31	63.09-6309	1.05-105
Approximate Output @ 50/60Hz										

\* Injection check valve is included with pumps rated to 100 psi (6.9 bar) maximum.

**NOTICE:** The information within this chart is solely intended for use as a guide. The output data is an approximation based on pumping water under a controlled testing environment. Many variables can affect the output of the pump. Stenner Pump Company recommends that all metering pumps undergo field calibration by means of analytical testing to confirm their outputs.

# MATERIALS OF CONSTRUCTION

## All Housings

Polycarbonate

## Pump Tube

Santoprene<sup>®\*</sup>, FDA approved or Versilon<sup>®\*\*</sup>

## Check Valve Duckbill

Santoprene<sup>®\*</sup>, FDA approved or Pellethane<sup>®†</sup>

## Pump Head Rollers

Polyethylene

## Roller Bushings

Oil impregnated bronze

## Suction/Discharge Tubing, Ferrules 1/4" & 6 mm

Polyethylene, FDA approved

## Tube Fittings & Injection Fittings

PVC or Polypropylene, NSF listed

## Connecting Nuts

PVC, NSF listed

## 3/8" Adapter

PVC or Polypropylene, NSF listed

## Suction Line Strainer and Cap

PVC or Polypropylene, NSF listed, with Ceramic Weight

## All Fasteners

Stainless steel

## Pump Head Latches

Polypropylene

## Leak Detect Clips, Springs, Pins

Hastelloy<sup>®††</sup>

\* Santoprene<sup>®</sup> is a registered trademark of Exxon Mobil Corporation.

\*\* Versilon<sup>®</sup> is a registered trademark of Saint-Gobain Performance Plastics.

† Pellethane<sup>®</sup> is a registered trademark of The Dow Company.

†† Hastelloy<sup>®</sup> is a registered trademark of Haynes International, Inc.

# ACCESSORY CHECKLIST

3 Connecting Nuts 1/4" or 3/8"

3 Ferrules 1/4" or 6 mm *Europe*

1 Injection Fitting 25 psi (1.7 bar) max. or 1 Injection Check Valve 100 psi (6.9 bar) max.

1 Weighted Suction Line Strainer 1/4", 3/8" or 6 mm *Europe*

1 20' Roll of Suction/Discharge Tubing 1/4" or 3/8", white, UV black or 6 mm white *Europe*

1 Additional Pump Tube

2 Additional Latches

1 Mounting Bracket

1 Quick Start Guide



# GENERAL INFORMATION SUMMARY

The S Series is an advanced peristaltic pump design with multiple programming features and performance indicators. The S Series offers practical and flexible functions for municipal, wastewater and industrial applications.

## PUMP FEATURES

- Brushless DC Motor with ball bearing support
- Switch mode power supply
- Microcontroller
- Blue OLED Display
- QuickPro® pump head with leak detect sensor
- Six button keypad on control panel

## OUTPUT

- 0.05 – 85.0 gpd, pressures to 25 psi
- 0.05 – 40.0 gpd, pressures to 100 psi

## MAIN MENU

### **CONFIGURATION** Configure the pump parameters ..... p12-28

- Summary ..... p12
- Display Brightness ..... p13
- Units ..... p14
- Clock ..... p15
- Calibration ..... p16-17
- Password ..... p18
- Tube Timer ..... p19
- Reset Totalizer ..... p20
- Leak Detect ..... p21
- Outputs (Relay) ..... p22-25
- Firmware Version ..... p26
- Reset Pump ..... p27
- Go To Main Menu ..... p28

### **CONTROL MODE** Select the mode of operation and set parameters ..... p29-52

- Summary ..... p29
- Manual ..... p30
- 4-20mA ..... p31-33
- 0-10VDC ..... p34-36
- Pulse ..... p37-38
- Hall Effect ..... p39-41
- 7 Day Timer ..... p42-44
- PPM Feed Constant Flow/Flow Switch ..... p45-47
- PPM Feed Variable Flow/Hall Effect ..... p48-50
- Cycle Timer ..... p51
- Go To Main Menu ..... p52

**RUN PUMP** Select RUN PUMP to put the pump in Operating mode (Configuration and Control Mode must be programmed before Run Pump is selected). The pump runs based on the programmed settings and the settings are shown in the Operating Display screen. .... p53-64





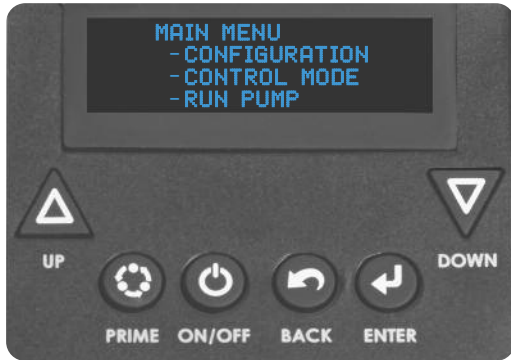

# GENERAL INFORMATION SUMMARY continued

## CONTROL PANEL



## NAVIGATION BUTTONS

The pump is controlled with 6 buttons. The chart indicates the function of each button on the control panel.

Button	General Function	Operating Mode Function
 <b>UP</b>	<ul style="list-style-type: none"> <li>· Moves up in a menu</li> <li>· Toggles between menu options</li> <li>· Increases a value</li> </ul>	Increases the speed percent in the <b>Manual</b> mode
 <b>DOWN</b>	<ul style="list-style-type: none"> <li>· Moves down in a menu</li> <li>· Toggles between options</li> <li>· Decreases a value</li> </ul>	Decreases the speed percent in the <b>Manual</b> mode
 <b>PRIME</b>	N/A	Runs pump at 100% speed while button is pressed
 <b>ON/OFF</b>	N/A	Turns pump control ON or OFF <b>WARNING: DOES NOT</b> remove power
 <b>BACK</b>	Moves one step back in a menu when permitted	Cycles the display through the units of output and the control mode specific parameters
 <b>ENTER</b>	Sets a value	Press and hold for 2 seconds to go to the <b>Main Menu</b>

# GENERAL INFORMATION SUMMARY

## PERFORMANCE INDICATORS

Pump Condition	Control Mode	Programmable Communication	
		Display Alarm on pump control panel	Three Output Relays to another pump, system or device
Tube Change	Manual, 4-20mA*, 0-10VDC*, Pulse, Hall Effect, 7 Day Timer, PPM Feed–Constant, PPM Feed–Variable, Cycle Timer	✓	————
Tube Leak		✓	✓
Standby		✓	✓
Drive Fault		✓	✓
Off		✓	✓
Run		————	✓
Mode Change		————	✓
Transfer		————	✓
Repeat Pulse		Manual, 4-20mA*, 0-10VDC*, Pulse, 7 Day Timer, PPM Feed–Constant, Cycle Timer	————
High Signal	4-20mA* or 0-10VDC*	✓	✓
Low Signal	4-20mA* or 0-10VDC*	✓	✓
High Flow	Hall Effect or PPM Feed-Variable	✓	✓
Low Flow	Hall Effect	✓	✓
Signal Overrun	Pulse	✓	✓

\* Scalable, Invertible

## SET UP

The very first time the pump is turned on, the display will show the Firmware Version followed by the **Main Menu** screen.

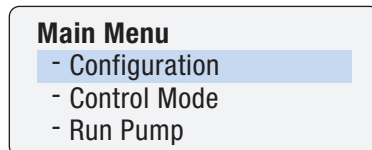
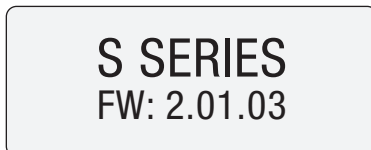

*The display will indicate the pump's software version.*

If the pump was previously programmed, the display will return to the mode it was in when it was turned off or if power was lost.

# CONFIGURATION MENU

## SUMMARY

Configure the pump parameters. Configuration should be completed at the initial set up.

### NAVIGATION

▲  
Moves up in a menu, toggles between options, or increase a value

▼  
Moves down in a menu, toggles between options, or decreases a value

Holding the ▲ or ▼ button causes the numbers to change rapidly.

↶  
Moves one step back in a menu, when permitted

←  
Sets a value in a menu

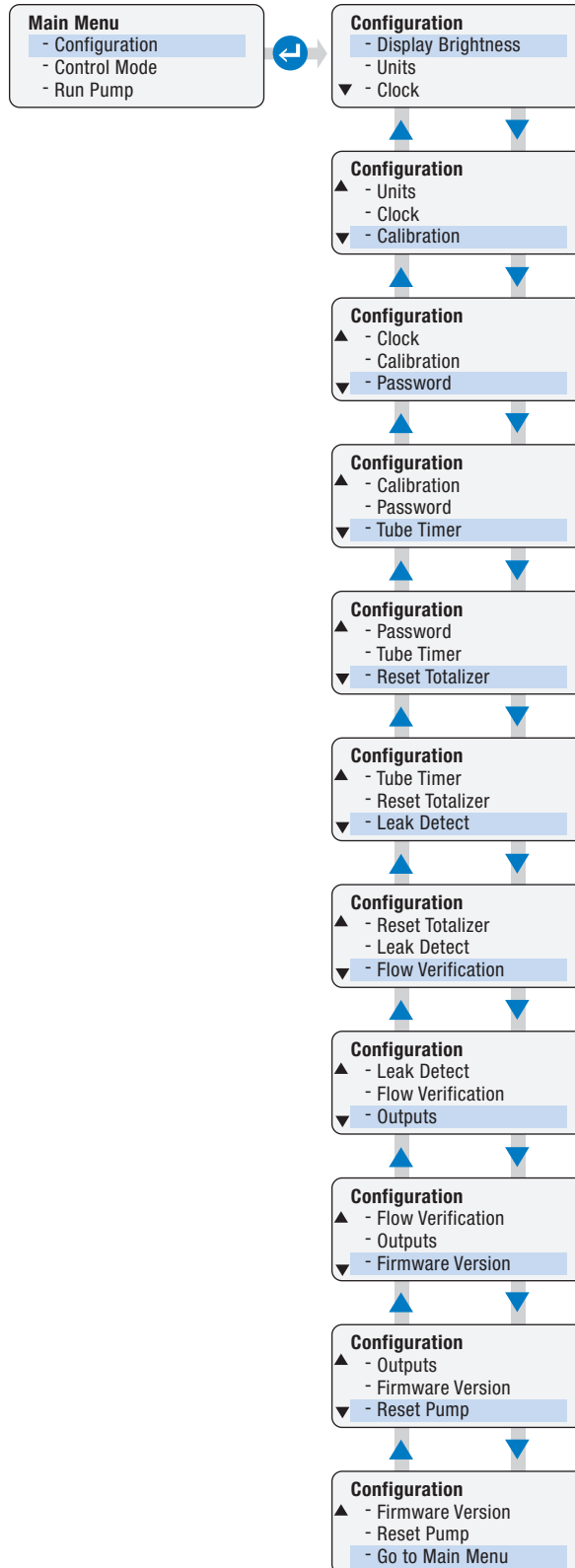

# CONFIGURATION MENU continued

## DISPLAY BRIGHTNESS

Allows user to adjust the brightness level of the pump display from 0% to 100%. There is some visibility at the minimum setting.

NOTE: For best performance and longevity, the display brightness should not be set higher than 50% for extended periods.

### NAVIGATION



Moves up in a menu, toggles between options, or increase a value

Holding the ▲ or ▼ button causes the numbers to change rapidly.



Moves down in a menu, toggles between options, or decreases a value



Moves one step back in a menu, when permitted



Sets a value in a menu

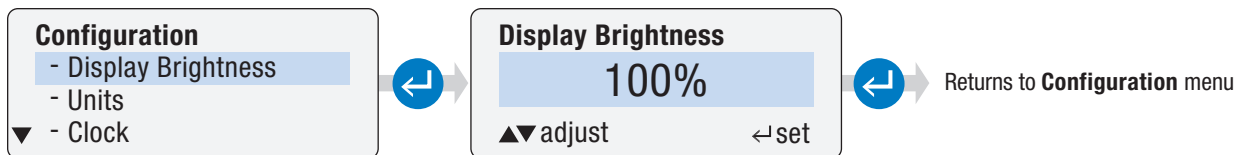

# CONFIGURATION MENU continued

## UNITS

Allows the user to set the unit of measure to Gallons or Liters. The selection appears in the pump display during **Control Mode** programming.

### NAVIGATION



Moves up in a menu, toggles between options, or increase a value

Holding the ▲ or ▼ button causes the numbers to change rapidly.



Moves down in a menu, toggles between options, or decreases a value



Moves one step back in a menu, when permitted



Sets a value in a menu

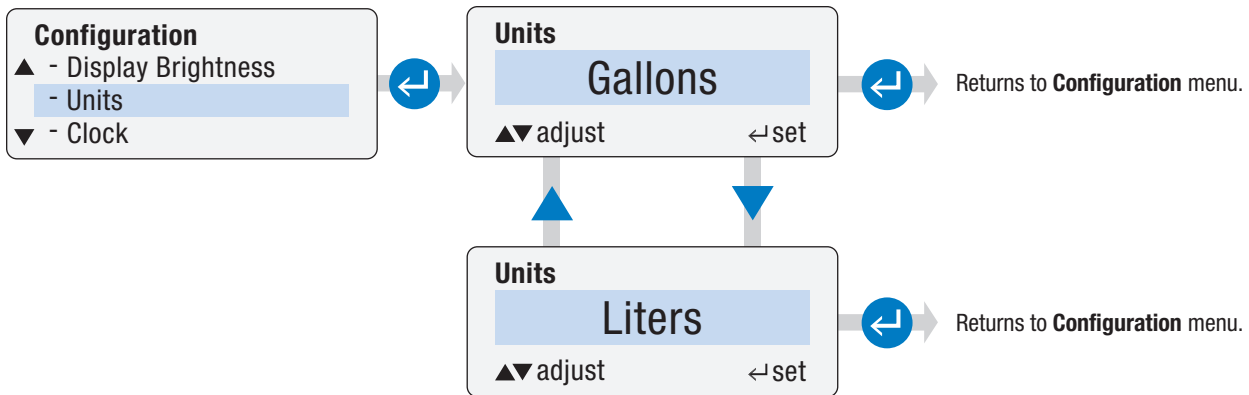

# CONFIGURATION MENU continued

## CLOCK

Allows the user to set the current day of the week and the time of the day. The time is set in a 24 hour clock format only.

NOTE: For the time, the first two digits that control the hour are highlighted together.

### NAVIGATION



Moves up in a menu, toggles between options, or increase a value

Holding the ▲ or ▼ button causes the numbers to change rapidly.



Moves down in a menu, toggles between options, or decreases a value



Moves one step back in a menu, when permitted



Sets a value in a menu

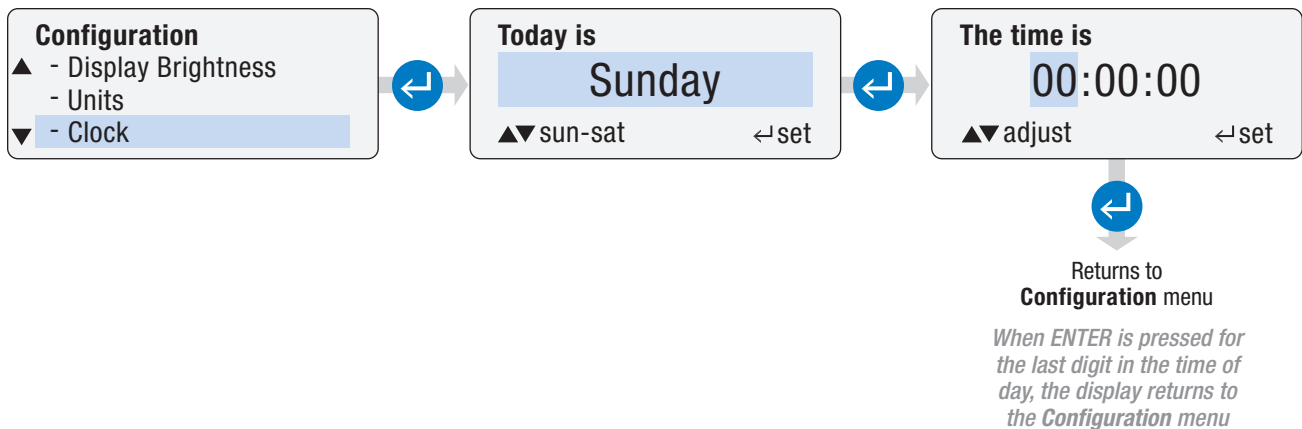

# CONFIGURATION MENU continued

## CALIBRATION page 1 of 2

Allows user to set the pump's maximum output. The units displayed in the **Calibration** submenu are controlled by the setting made in the **Units** submenu.

**IMPORTANT:** The value entered (in **Calibration**) for the pump's maximum output is used to calculate the pump's required output for the operating mode in **Run Pump**. The value is also used to calculate the pump's required run speed in the **PPM Feed** submenu in **Control Mode**. For the most accurate dosing possible, determine the actual pump output. Conduct a drawdown from a graduated calibration column against the discharge run and pressure, equivalent to the intended installation.

### NAVIGATION



Moves up in a menu, toggles between options, or increase a value

Holding the ▲ or ▼ button causes the numbers to change rapidly.



Moves down in a menu, toggles between options, or decreases a value



Moves one step back in a menu, when permitted



Sets a value in a menu

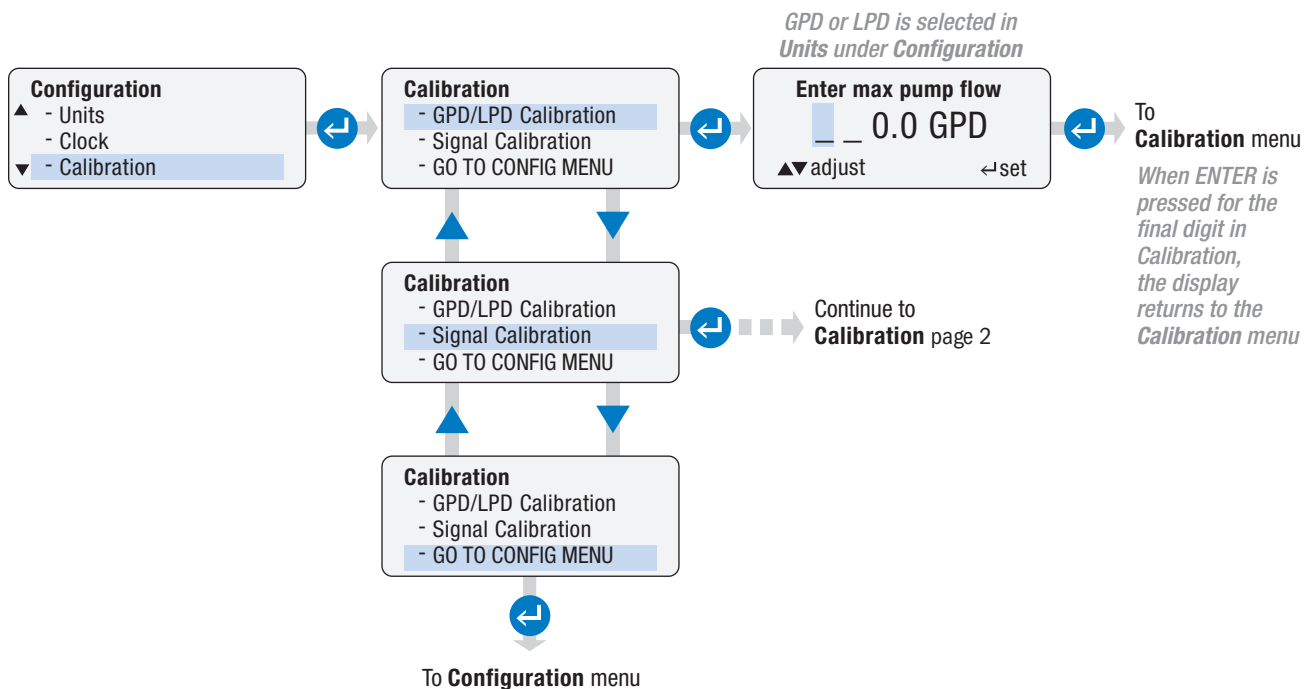



# CONFIGURATION MENU continued

## CALIBRATION page 2 of 2

Allows user to calibrate analog signal inputs and outputs.

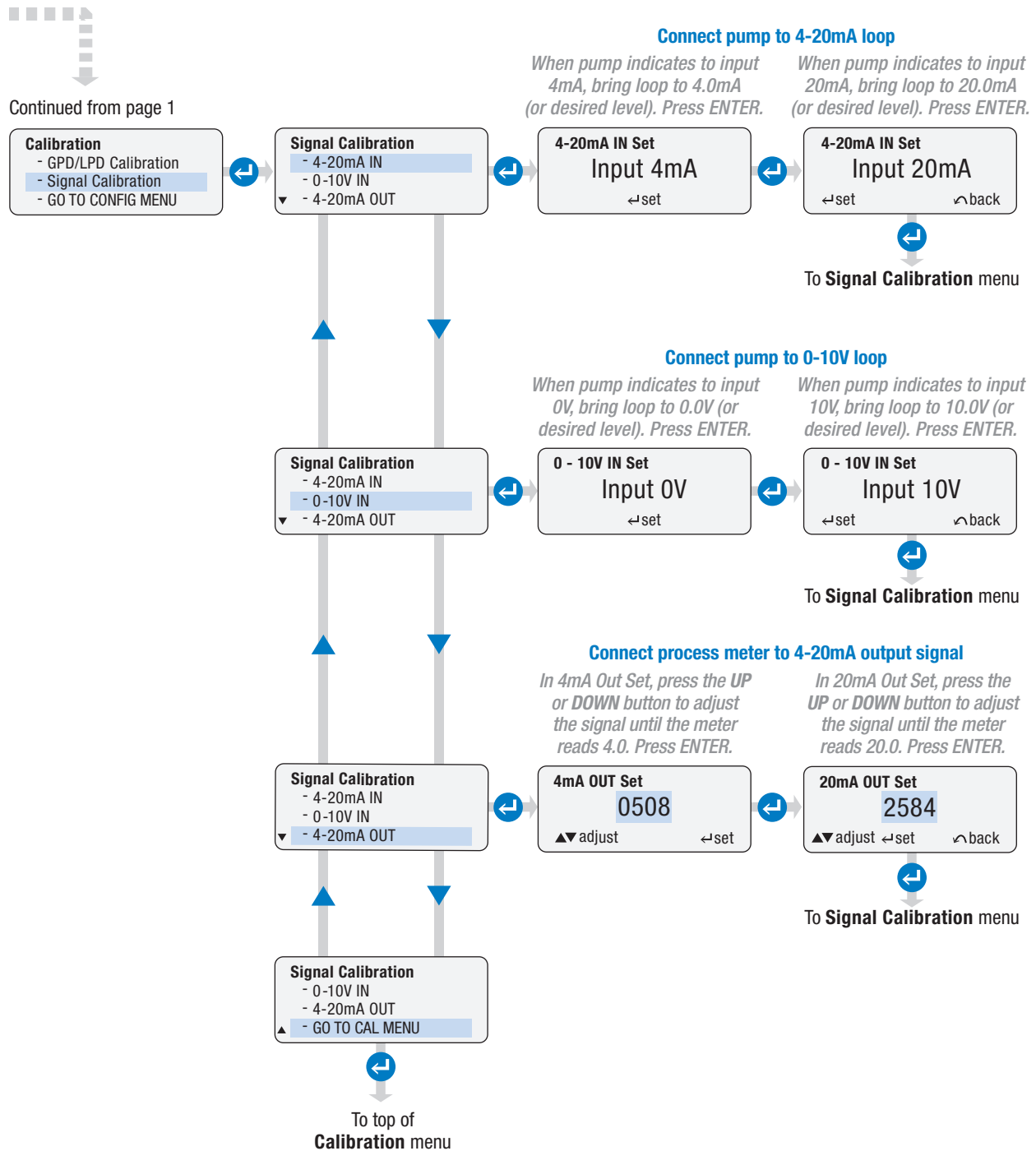

Tip: To get the most accurate response, always calibrate the input and output signal loops. Details on how to calibrate the output loop are located in the Connections 4-20mA Output section in this manual.

# CONFIGURATION MENU continued

## PASSWORD

Allows user to set a password to prevent unauthorized changes to the pump settings.

- Each digit can be set for 0-9 or A-Z.
- When the password is set, it must be entered during the Operating Display mode (in **Run Pump**) in order to enter the **Main Menu**.
- Leaving the password blank disables the password feature. The password is disabled by default.

### NAVIGATION



Moves up in a menu, toggles between options, or increase a value

Holding the ▲ or ▼ button causes the numbers to change rapidly.



Moves down in a menu, toggles between options, or decreases a value



Moves one step back in a menu, when permitted



Sets a value in a menu

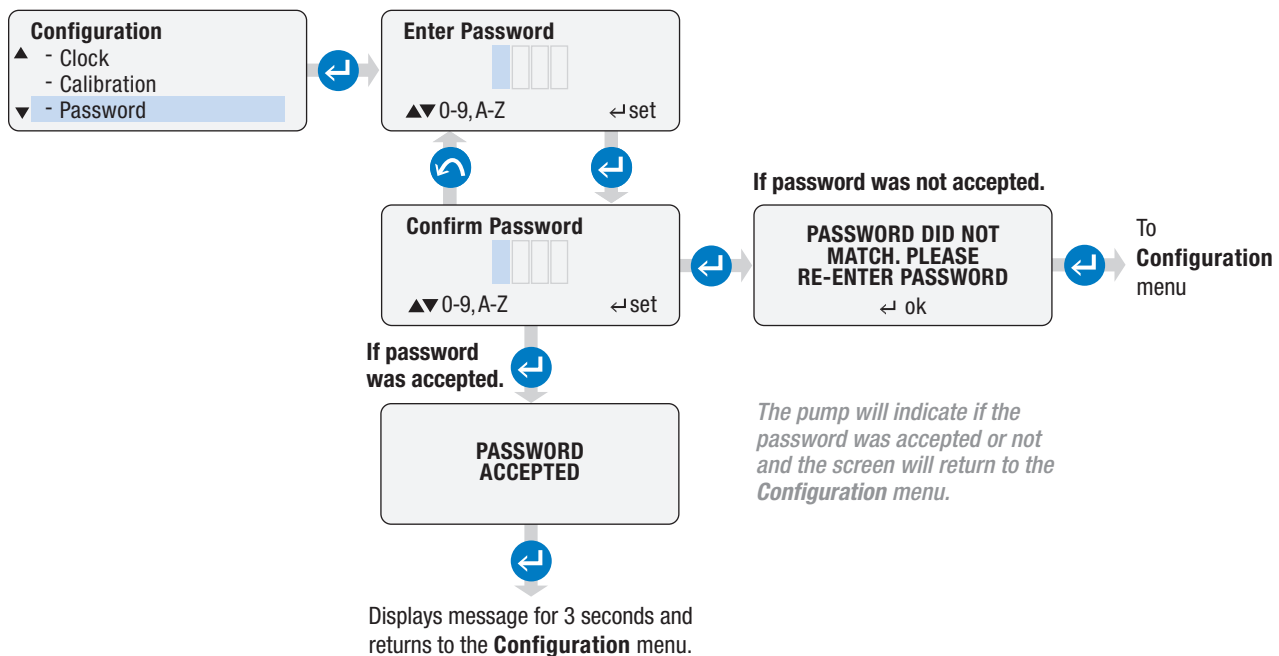

# CONFIGURATION MENU continued

## TUBE TIMER

Allows user to set the tube run time in hours, to initiate the tube change indicator. When the set time is reached, the Operating Display shows **Tube Change**.

- After the tube is replaced, reset the current run time to zero.

### NAVIGATION



Moves up in a menu, toggles between options, or increase a value



Moves down in a menu, toggles between options, or decreases a value



Moves one step back in a menu, when permitted



Sets a value in a menu

Holding the ▲ or ▼ button causes the numbers to change rapidly.

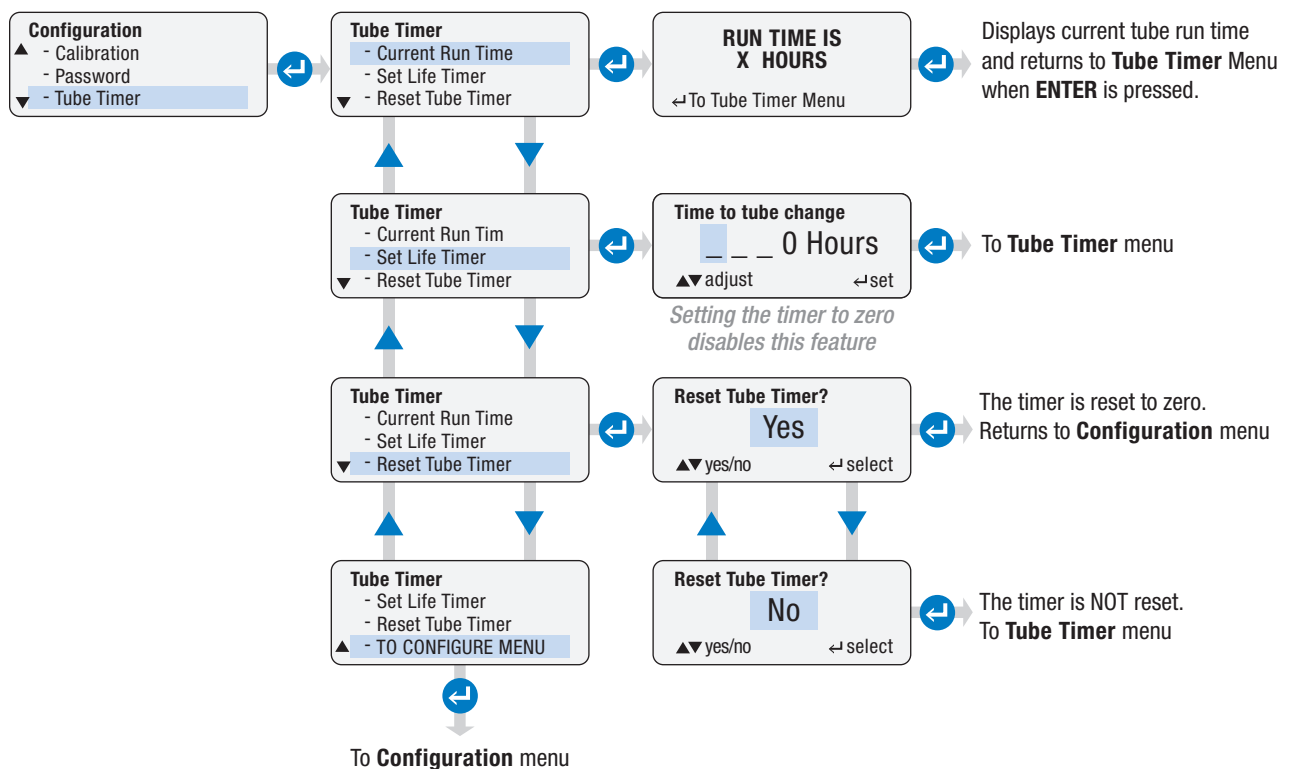

# CONFIGURATION MENU continued

## RESET TOTALIZER

Allows user to reset the flow totalizer when using the **Pulse, Hall Effect, or PPM Feed** control modes.

### NAVIGATION



Moves up in a menu, toggles between options, or increase a value

Holding the ▲ or ▼ button causes the numbers to change rapidly.



Moves down in a menu, toggles between options, or decreases a value



Moves one step back in a menu, when permitted



Sets a value in a menu

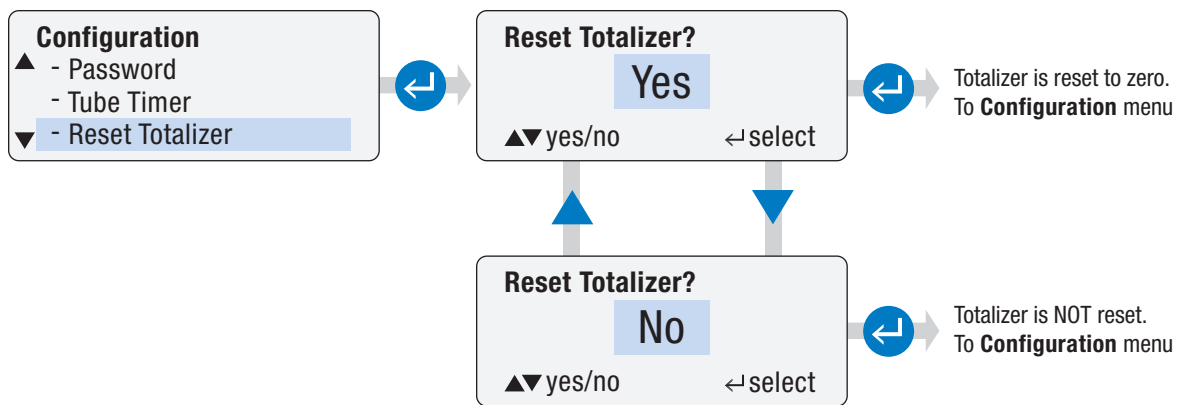

# CONFIGURATION MENU continued

## LEAK DETECT

The leak detect function detects when solution is present in the pump head. When a leak is detected, the tube icon will appear on the display.

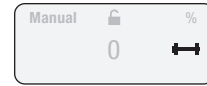

The user can:

- Set the pump to alarm on tube leak and "Tube Leak" will appear on the display
- Set a delay, in seconds, for the alarm to activate
- Set the pump to stop, or not, upon the alarm

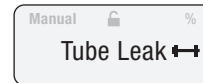

Leak detect is accomplished by sensing conductivity between two metal clips in the tube housing cover. The leak detect bracket and leak detect tube housing cover must be installed in order to use this option.

The alarm on leak detect is disabled by default. The delay for the alarm to activate is also set to zero by default.

Tip: The leak detect sensitivity is factory pre-set to distinguish between water and typical water treatment chemicals. Adjust the sensitivity according to the specific chemical utilized in the application. Adjust with the potentiometer located under the signal cover. Instruction for adjusting are located in p75 *Connections Leak Detect* in this manual.

### NAVIGATION



Moves up in a menu, toggles between options, or increase a value

Holding the ▲ or ▼ button causes the numbers to change rapidly.



Moves down in a menu, toggles between options, or decreases a value



Moves one step back in a menu, when permitted



Sets a value in a menu

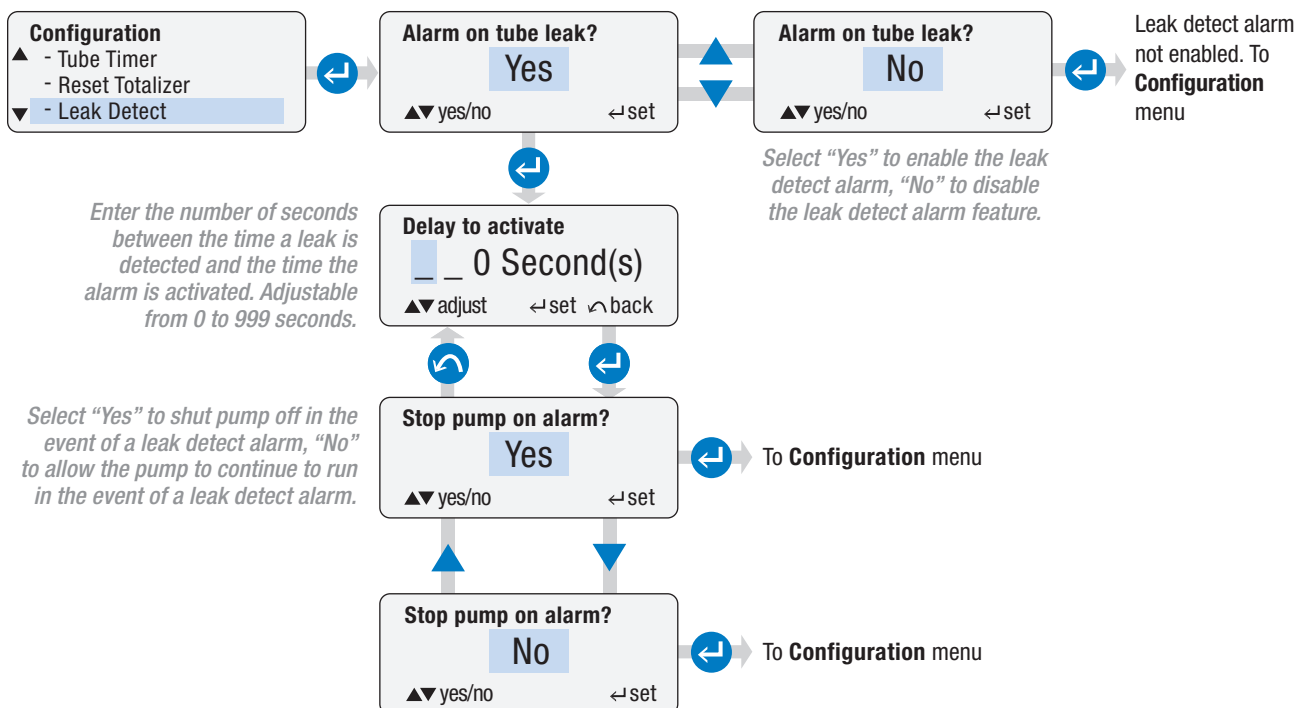

# CONFIGURATION MENU continued

## OUTPUTS (RELAY) page 1 of 4

Allows user to configure the three internal relays for output indication from the pump to a control system, another pump or miscellaneous receptacle.

- The S Series Pump has three dry contact relays. The relays can be programmed Normally Open (NO) or Normally Closed (NC) to suit the specific application.
- The relays are rated for 24VDC @ 50mA max.
- Each relay can be individually set to activate on any of the following conditions. The relay will activate any time one of the selected conditions exists. The conditions are listed below:

### OUTPUTS – ALL MODES OF OPERATION

**Leak Detect:** Activates relay if pump alarms on leak detect.

**Run:** Activates the relay whenever the pump is running.

**Transfer:** Activates the relay in the event the pump is shut down due to a pump alarm condition.

- If the primary pump shuts down due to a pump alarm (which can be a drive fault or tube leak detect) or loss of power, the relay will open. The open relay will allow the backup pump to immediately start running.
- When a drive fault or loss of power occurs, the pump will shut down automatically. The user must choose to shut down the pump when the leak detect alarm is programmed and enabled.
- Transfer is intended to be programmed as Normally Closed (NC) and the output used as the input to the Standby function of a backup pump. The backup pump is programmed in the same mode as the primary pump and powered off of a separate circuit.
- When programming a relay for the Transfer function, DO NOT select any other condition for the relay to be activated.

**Drive Fault:** Activates the relay if the pump shuts down due to a drive fault error.

**Standby:** Activates the relay if the pump goes into **Standby**.

**Off:** Activates the relay if the pump is turned OFF from the control panel.

**Mode Change:** Activates the external alarm if the pump's mode of operation is changed.

- Only one mode of operation can be selected. The relay must only be programmed for the current mode of operation.

### OUTPUTS – SPECIFIC MODES OF OPERATION

#### Low Signal – 4-20mA or 0-10VDC

- Activates the relay if the pump alarms on a Low Signal. The Low Signal alarm is non-latching and will clear itself if the signal returns back to its normal range.

#### High Signal – 4-20mA or 0-10VDC

- Activates the relay if the pump alarms on a High Signal. The High Signal alarm is non-latching and will clear itself if the signal returns back to its normal range.

#### Low Flow – Hall Effect

- Activates the relay if the pump alarms on a low process flow.

#### High Flow – Hall Effect or PPM Feed-Variable

- Activates the relay if the pump alarms on a high process flow.

#### Signal Overrun – Pulse

- Activates the relay if the pump receives input signals during a run cycle.

#### Repeat Pulse – Manual, 4-20mA, 0-10VDC, Pulse, 7 Day Timer, PPM Feed-Constant, Cycle Timer

- Activates the relay when the pump receives a dry contact input signal. The Repeat Pulse feature is used to repeat an incoming signal and relay it to another pump or controller.

# CONFIGURATION MENU continued

## OUTPUTS (RELAY) page 2 of 4

- Program the individual output relays (1, 2, and/or 3) as desired. Example illustrates selecting Relay #1
- Enable or disable the relays as desired.

### NAVIGATION



Moves up in a menu, toggles between options, or increase a value



Moves down in a menu, toggles between options, or decreases a value



Moves one step back in a menu, when permitted



Sets a value in a menu

Holding the ▲ or ▼ button causes the numbers to change rapidly.

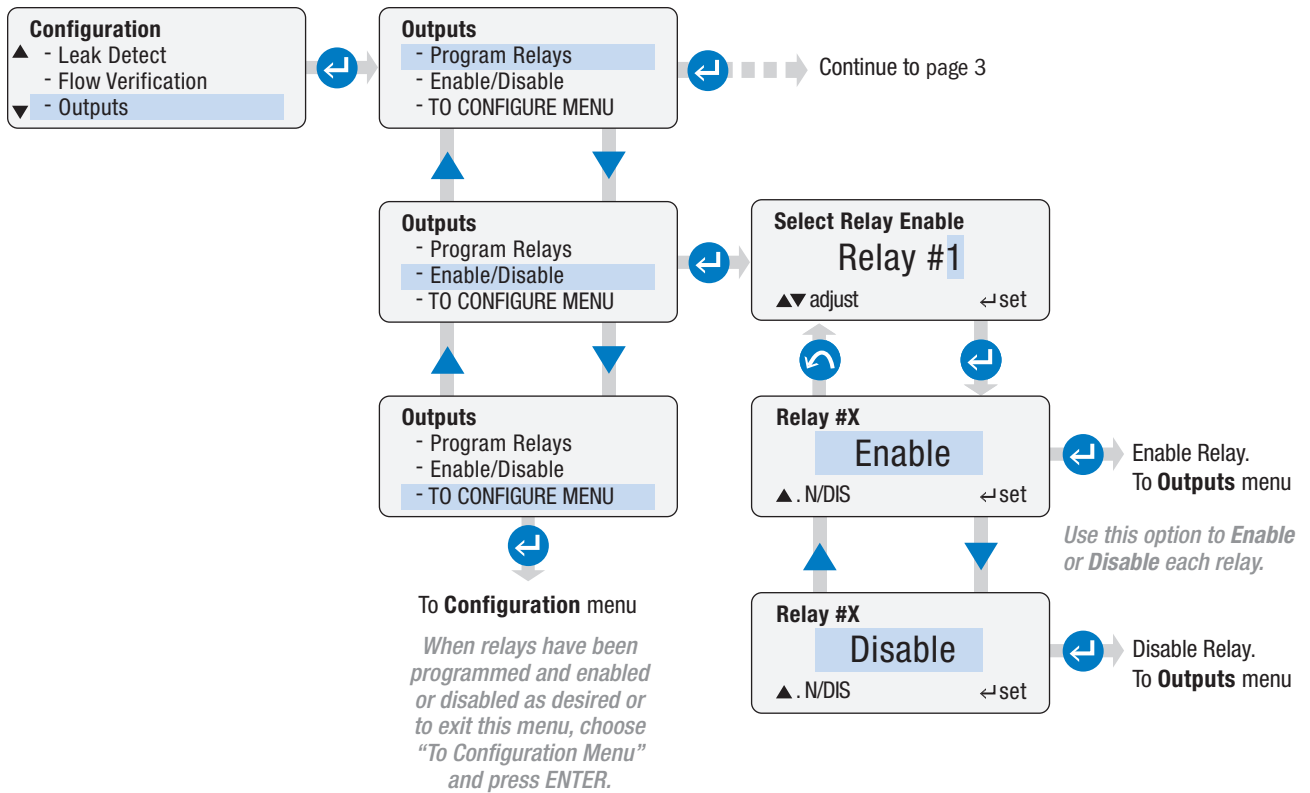

# CONFIGURATION MENU continued

## OUTPUTS (RELAY) page 3 of 4

Continued from page 2

**Outputs**

- Program Relays
- Enable/Disable
- To Configure menu

**Select Relay**  
Relay #1  
▲▼ adjust    ↵ set

**Relay #1**  
Normally Open  
▲ n.o./n.c.    ↵ set

**Relay #1**  
Normally Closed  
▲ n.o./n.c.    ↵ set

Select Relay #1,2, or 3 to program and press ENTER.

Program the individual output relays (1, 2, and/or 3) as desired. Example below illustrates selecting Relay #1.

Any Control Mode

Manual  
4-20mA  
0-10VDC  
Pulse  
7-Day  
PPM-Constant  
Cycle Timer

Any Control Mode

4-20mA  
or  
0-10VDC

**Relay #1**  
Leak Detect    Off  
▲▼ on/off    ↵ set

**Relay #1**  
Flow Detect    Off  
▲▼ on/off    ↵ set

**Relay #1**  
Repeat Pulse    Off  
▲▼ on/off    ↵ set

**Relay #1**  
Run    Off  
▲▼ on/off    ↵ set

**Relay #1**  
Transfer    Off  
▲▼ on/off    ↵ set

**Relay #1**  
Low Signal    Off  
▲▼ on/off    ↵ set

**Relay #1**  
High Signal    Off  
▲▼ on/off    ↵ set

**Relay #1**  
Low Flow    Off  
▲▼ on/off    ↵ set

**Relay #1**  
High Flow    Off  
▲▼ on/off    ↵ set

**Relay #1**  
Drive Fault    Off  
▲▼ on/off    ↵ set

**Relay #1**  
Overrun    Off  
▲▼ on/off    ↵ set

**Relay #1**  
Standby    Off  
▲▼ on/off    ↵ set

**Relay #1**  
Off    Off  
▲▼ on/off    ↵ set

**Relay #1**  
Mode Change    Off  
▲▼ on/off    ↵ set

Hall Effect

Hall Effect  
or  
PPM Feed-Variable

Any Control Mode

Pulse

Any Control Mode

On Continue to page 4

Select "ON" to enable the relay to activate for the specific condition.

Select "OFF" to deactivate the relay for the specific condition. "OFF" is the default mode.

NOTE: All condition options are shown. Not all conditions are applicable to all control modes.

To Outputs menu



# CONFIGURATION MENU continued

## OUTPUTS (RELAY) page 4 of 4

Continued from page 3

Relay #1  
Mode Change On  
▲▼ on/off ←set

ONLY ONE MODE  
CAN BE SELECTED  
← ok

*If Mode Change is enabled, then select "ON" to enable only ONE mode operation.*

*The mode must be the mode the pump will be programmed to run in.*

*As soon as any mode is selected, the display will go to the Outputs menu so the relays can be enabled.*

Relay #1 Mode Change  
Manual Off  
▲▼ on/off ←set

On → To Outputs menu

Off ←

Relay #1 Mode Change  
4-20mA Off  
▲▼ on/off ←set

On → To Outputs menu

Off ←

Relay #1 Mode Change  
0-10 VDC Off  
▲▼ on/off ←set

On → To Outputs menu

Off ←

Relay #1 Mode Change  
7 Day Timer Off  
▲▼ on/off ←set

On → To Outputs menu

Off ←

Relay #1 Mode Change  
Pulse Off  
▲▼ on/off ←set

On → To Outputs menu

Off ←

Relay #1 Mode Change  
Cycle Timer Off  
▲▼ on/off ←set

On → To Outputs menu

Off ←

Relay #1 Mode Change  
Hall Effect Off  
▲▼ on/off ←set

On → To Outputs menu

Off ←

Relay #1 Mode Change  
PPM Feed Off  
▲▼ on/off ←set

On → To Outputs menu

Off ←

To Outputs menu

# CONFIGURATION MENU continued

## FIRMWARE VERSION

Allows user to check the firmware version code in the pump.

### NAVIGATION



Moves up in a menu, toggles between options, or increase a value

Holding the ▲ or ▼ button causes the numbers to change rapidly.



Moves down in a menu, toggles between options, or decreases a value



Moves one step back in a menu, when permitted



Sets a value in a menu

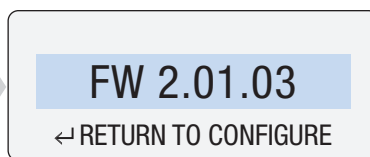
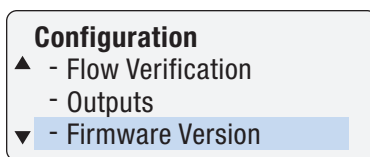

To Configuration menu

*The display will indicate the pump's software version.*

# CONFIGURATION MENU continued

## RESET PUMP

Allows user to reset the pump and return the pump to factory default settings.

### NAVIGATION



Moves up in a menu, toggles between options, or increase a value

Holding the ▲ or ▼ button causes the numbers to change rapidly.



Moves down in a menu, toggles between options, or decreases a value



Moves one step back in a menu, when permitted



Sets a value in a menu

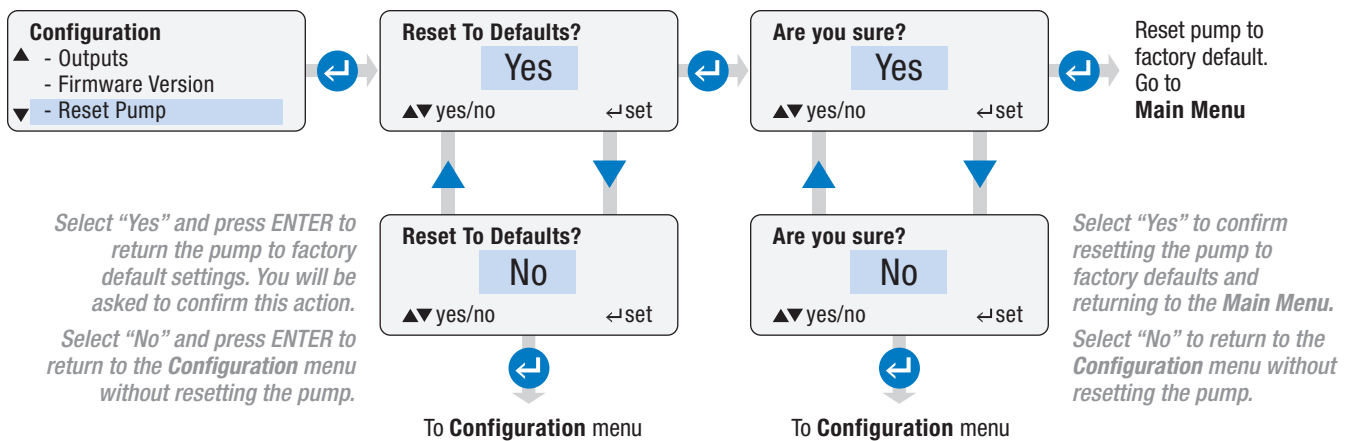

# CONFIGURATION MENU continued

## GO TO MAIN MENU

Allows user to return to the **Main Menu**.

### NAVIGATION



Moves up in a menu, toggles between options, or increase a value

Holding the ▲ or ▼ button causes the numbers to change rapidly.



Moves down in a menu, toggles between options, or decreases a value



Moves one step back in a menu, when permitted



Sets a value in a menu

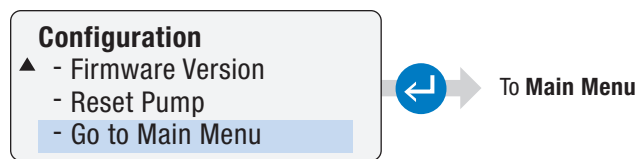

# CONTROL MODES MENU

## SUMMARY

Select the mode of operation and set the parameters.

### NAVIGATION



Moves up in a menu, toggles between options, or increase a value

Holding the ▲ or ▼ button causes the numbers to change rapidly.



Moves down in a menu, toggles between options, or decreases a value



Moves one step back in a menu, when permitted



Sets a value in a menu

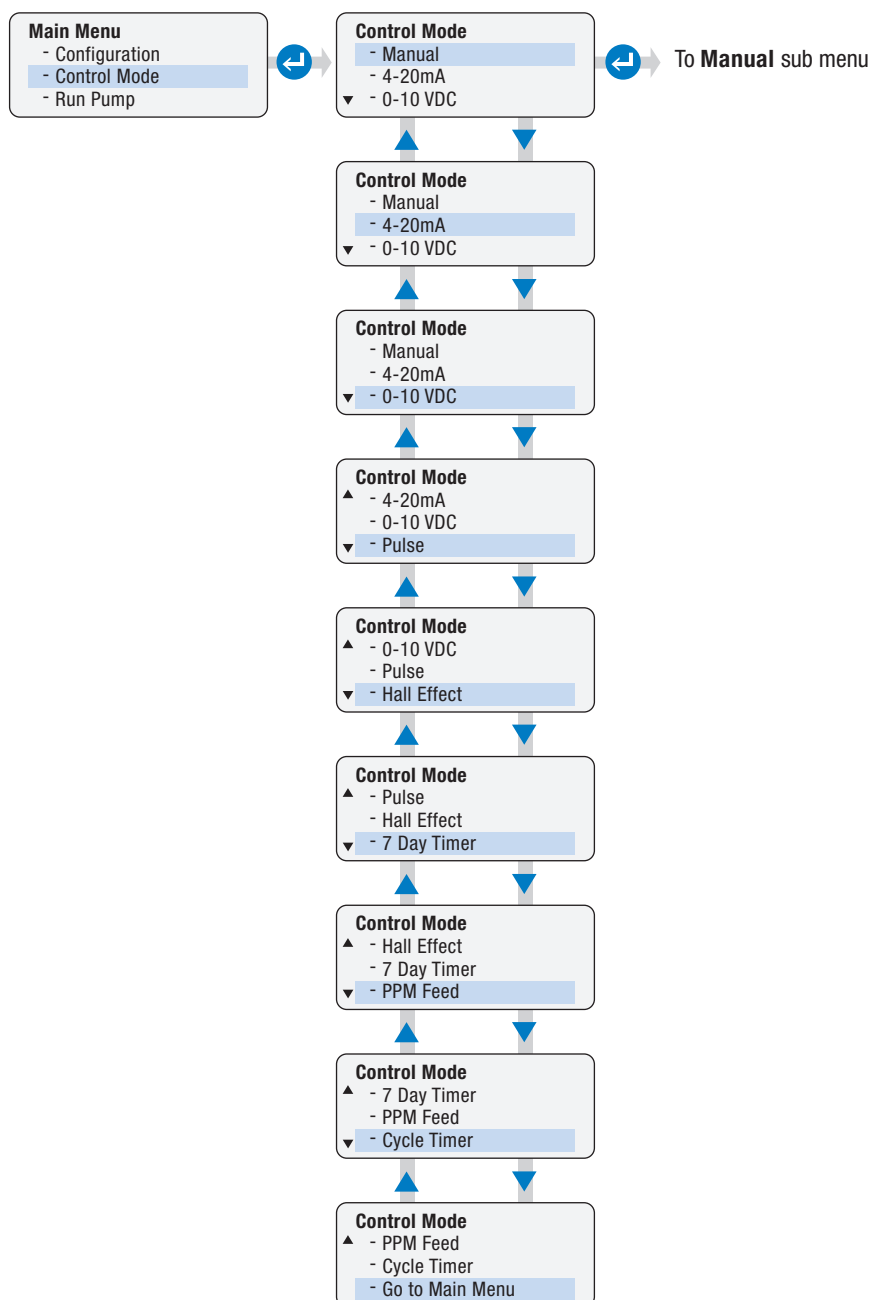

# CONTROL MODES MENU continued

## MANUAL

Allows user to control the pump speed manually.

Speed can be adjusted from 0 to 100% in one percent increments.

### NAVIGATION



Moves up in a menu, toggles between options, or increase a value

Holding the ▲ or ▼ button causes the numbers to change rapidly.



Moves down in a menu, toggles between options, or decreases a value



Moves one step back in a menu, when permitted



Sets a value in a menu

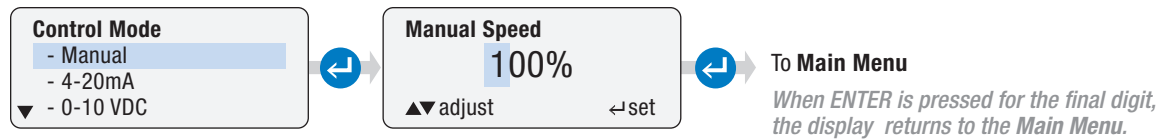

# CONTROL MODES MENU continued

## 4-20mA page 1 of 3

Allows user to configure the pump to respond proportionally to a 4-20mA analog signal. The pump's speed varies according to the level of the 4-20mA signal. The response to the signal can be scaled or inverted (refer to Diagram 1, 2 & 3).

**⚠ WARNING** When operating in an inverted response curve where the minimum signal is associated with the maximum pump speed, the pump will run at the maximum set speed if the signal is lost. It is extremely important to properly set the alarms to prevent overfeed on a loss of signal.

**⚠ CAUTION** **MAXIMUM SIGNAL VOLTAGE LEVEL IS 36VDC.**

To customize the pump response, set the signal values and the pump speed percent for the high and low range of the signals (refer to Diagram 1).

The signal level and associated speed set points can be set to any level, as long as there is at least 1mA difference between the minimum and maximum signal level and a 10% difference in the speed percent between the two points (refer to Diagram 3).

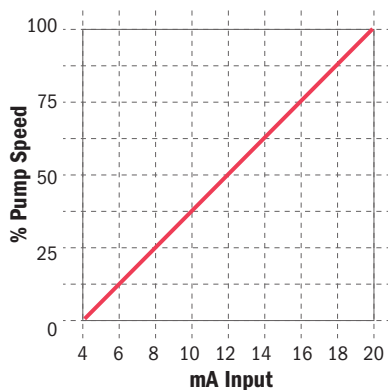

**Diagram 1**

Example of standard 4-20mA response curve. Pump programmed to 0% speed @ 4.0mA and 100% speed @ 20.0mA.

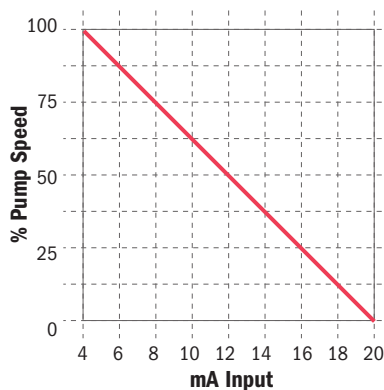

**Diagram 2**

Example of standard 20-4mA inverted response curve. Pump programmed to 100% speed @ 4.0mA and 0% speed @ 20.0mA.

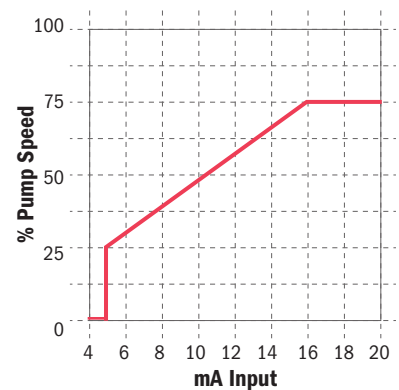

**Diagram 3**

Example of response curve with pump programmed to 25% speed at 5.0mA and 75% speed at 16.0mA.

# CONTROL MODES MENU continued

## 4-20mA page 2 of 3

To program the pump for 4-20mA control mode, set the response curve in **Program Settings**, return to the **4-20mA Control** menu and program the desired options under **Alarm Settings**, then exit to the **Main Menu** via the **Go To Main Menu** option.

### NAVIGATION



Moves up in a menu, toggles between options, or increase a value



Moves down in a menu, toggles between options, or decreases a value



Moves one step back in a menu, when permitted



Sets a value in a menu

Holding the ▲ or ▼ button causes the numbers to change rapidly.

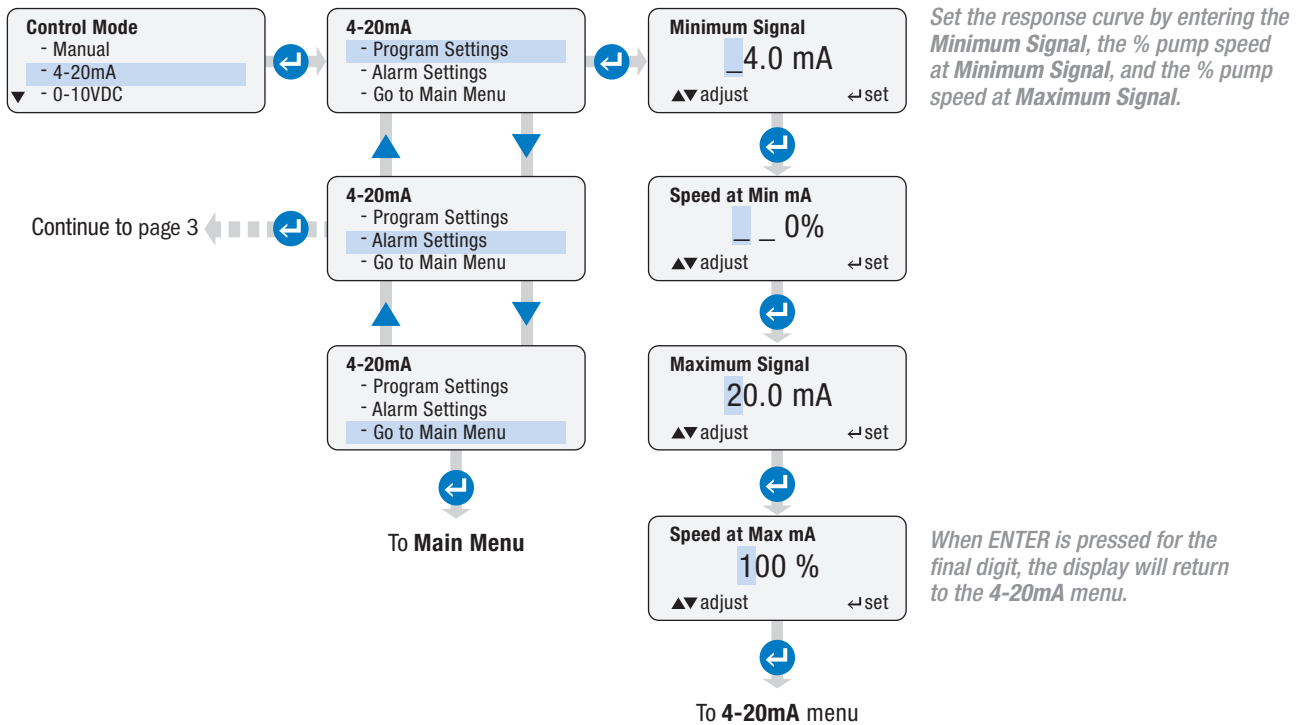



# CONTROL MODES MENU continued

## 4-20mA page 3 of 3

NOTE: Signal alarms are non-latching and will clear automatically when the signal returns to specified operating range. Alarms activate when settings are exceeded.

### NAVIGATION



Moves up in a menu, toggles between options, or increase a value

Holding the ▲ or ▼ button causes the numbers to change rapidly.



Moves down in a menu, toggles between options, or decreases a value



Moves one step back in a menu, when permitted



Sets a value in a menu

Continued from page 2

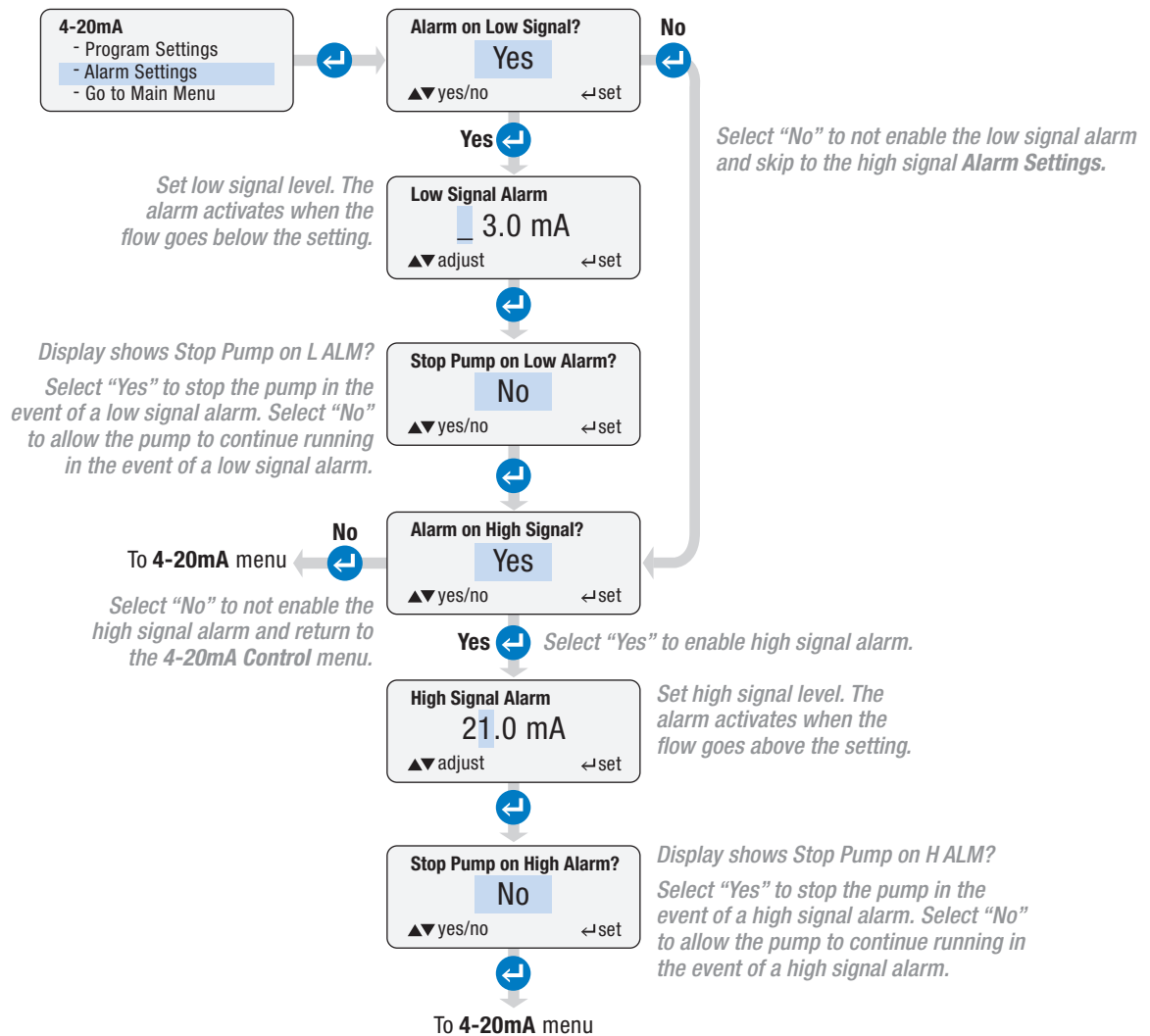

# CONTROL MODES MENU continued

## 0-10VDC page 1 of 3

Allows user to configure the pump to respond proportionally to a 0-10VDC analog signal. The pump's speed varies according to the level of the 0-10VDC signal. The response to the signal can be scaled or inverted (refer to Diagram 1, 2 & 3).

**⚠ WARNING** When operating in an inverted response curve where the minimum signal is associated with the maximum pump speed, the pump will run at the maximum set speed if the signal is lost. It is extremely important to properly set the alarms to prevent overfeed on a loss of signal. The user must enter the minimum signal set point above zero (for example, 0.1VDC) so that a low signal alarm is enabled at 0VDC.

To customize the pump response, set the signal values and the pump speed percent for the high and low range of the signals (refer to Diagram 1).

The signal level and associated speed set points can be set to any level, as long as there is at least 1VDC difference between the minimum and maximum signal level and a 10% difference in the speed percent between the two points (refer to Diagram 3).

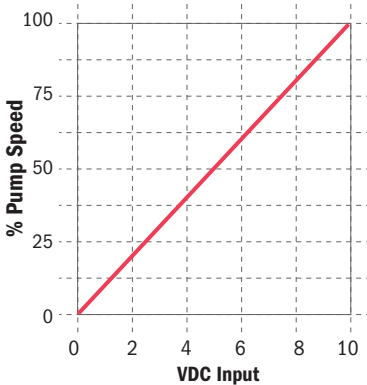

**Diagram 1**

Example of standard 0-10VDC response curve. Pump set to 0% speed @ 0.0VDC and 100% speed @ 10.0VDC.

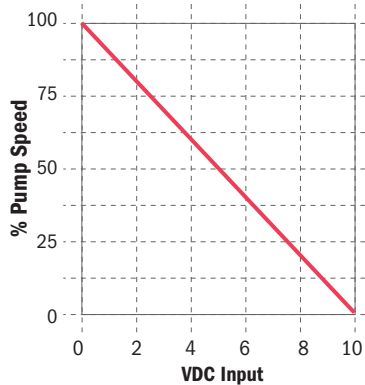

**Diagram 2**

Example of 10-0VDC inverted response curve. Pump set to 100% speed @ 0.0VDC and 0% speed @ 10.0 VDC.

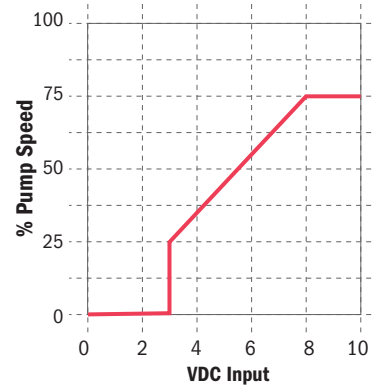

**Diagram 3**

Example of response curve with pump set to 25% speed @ 3.0VDC and 75% speed @ 8.0VDC.

# CONTROL MODES MENU continued

## 0-10VDC page 2 of 3

To program the pump for 0-10VDC control mode, set the response curve in **Program Settings**, return to the **0-10VDC Control** menu and program the desired options under **Alarm Settings**, then exit to the **Main Menu** via the **Go To Main Menu** option.

### NAVIGATION



Moves up in a menu, toggles between options, or increase a value



Moves down in a menu, toggles between options, or decreases a value



Moves one step back in a menu, when permitted



Sets a value in a menu

Holding the ▲ or ▼ button causes the numbers to change rapidly.

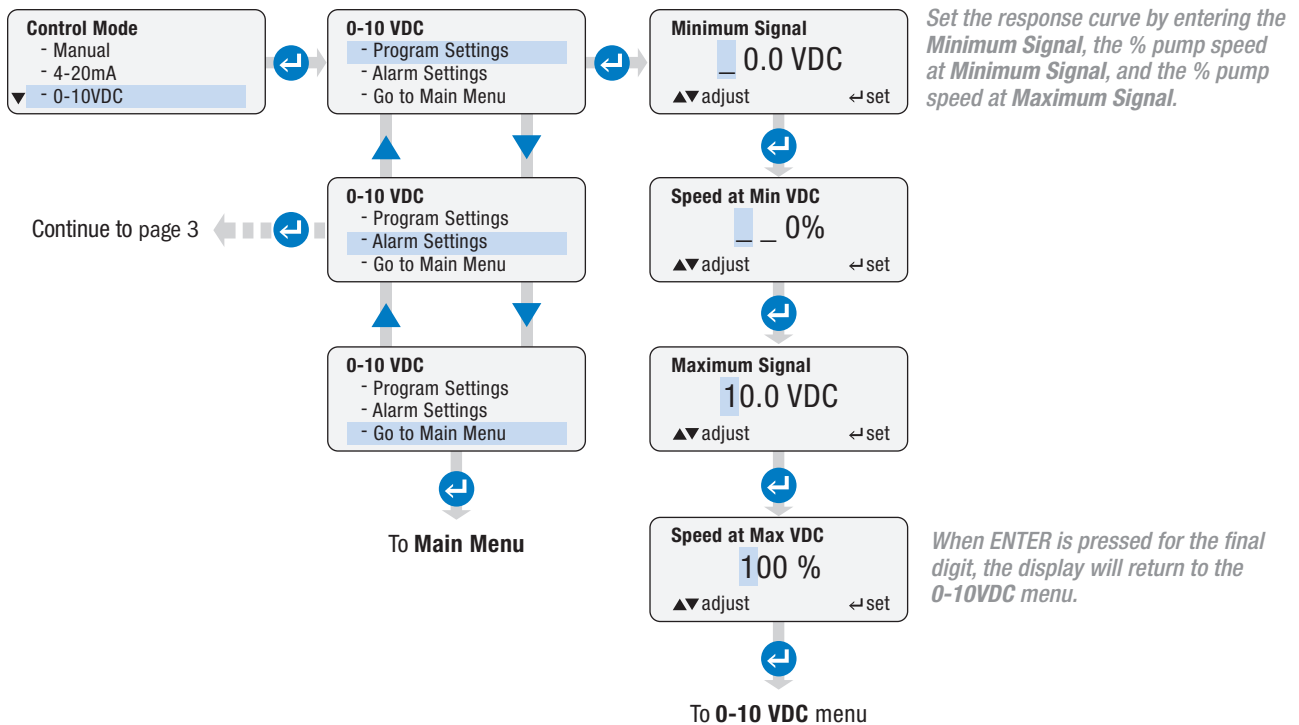

# CONTROL MODES MENU continued

## 0-10VDC page 3 of 3

NOTE: Signal alarms are non-latching and will clear automatically when the signal returns to specified operating range. Alarms activate when settings are exceeded.

### NAVIGATION



Moves up in a menu, toggles between options, or increase a value



Moves down in a menu, toggles between options, or decreases a value



Moves one step back in a menu, when permitted



Sets a value in a menu

Holding the ▲ or ▼ button causes the numbers to change rapidly.

Continued from page 2

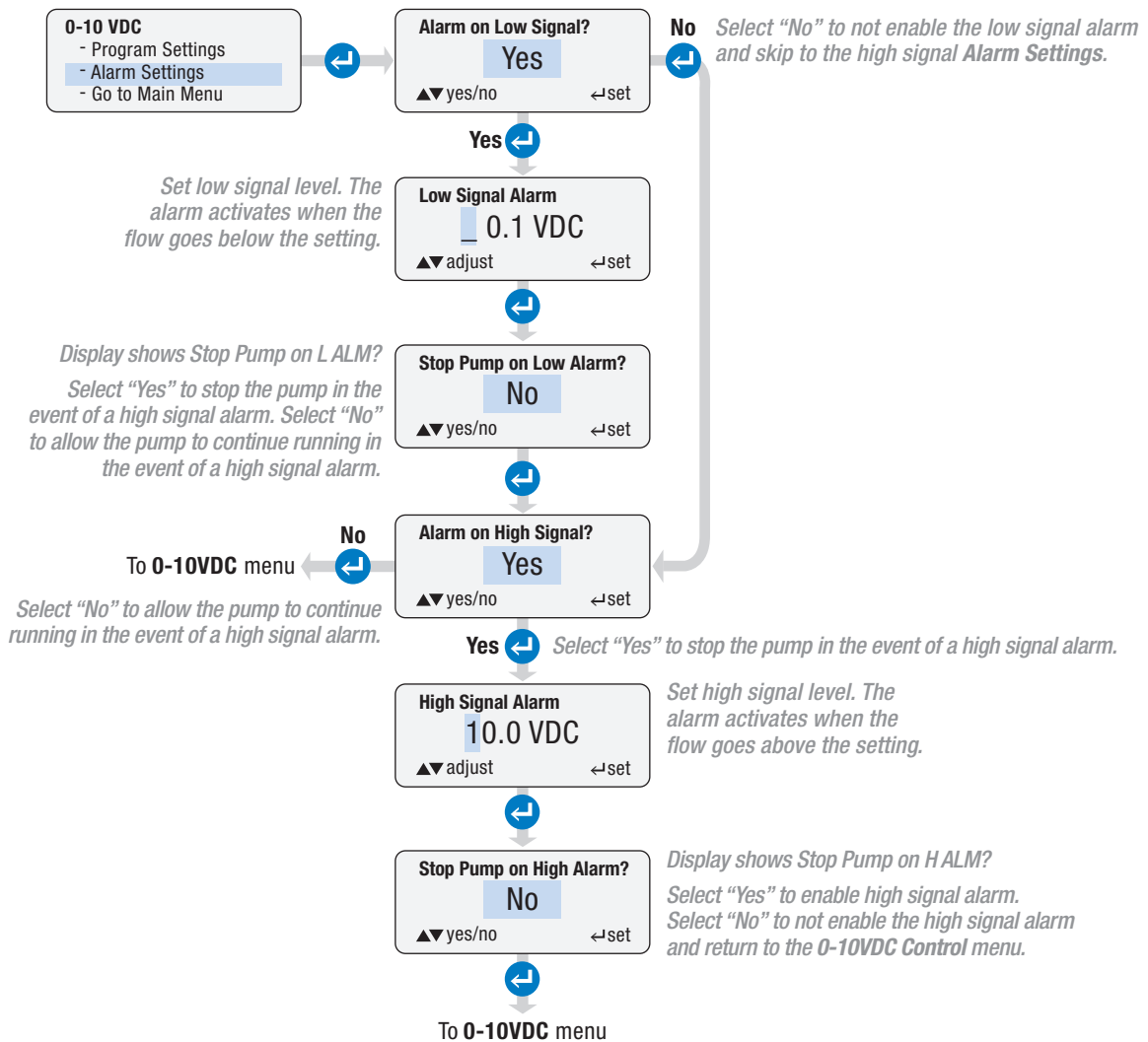

# CONTROL MODES MENU continued

## PULSE page 1 of 2

Allows user to configure the pump to run for a specified period of time when it receives a specified number of signals from a dry contact or an open collector input.

To program the pump for **Pulse** control mode, set the activation parameters in **Program Settings**, return to the **Pulse Control** menu and program the desired options under **Alarm Settings**, then exit to the **Main Menu** via the **Go To Main Menu** option.

The minimum allowable run time is 20.0 seconds.

**⚠ CAUTION** A signal overrun occurs when the pump receives sufficient pulses to activate another run cycle while the pump is already in a run cycle. This means that the process flow is greater than what the program settings allow for. The pump will ignore an activation while it is in a run cycle. A signal overrun condition will lead to incorrect dosing.

### NAVIGATION



Moves up in a menu, toggles between options, or increase a value

Holding the ▲ or ▼ button causes the numbers to change rapidly.



Moves down in a menu, toggles between options, or decreases a value



Moves one step back in a menu, when permitted



Sets a value in a menu

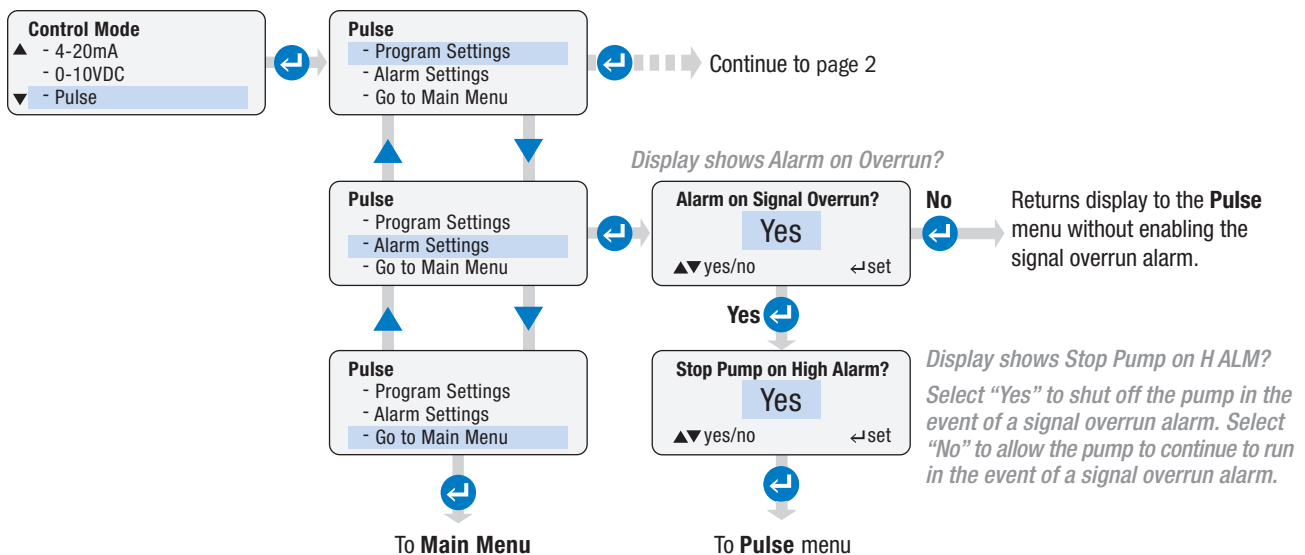

# CONTROL MODES MENU continued

## PULSE page 2 of 2

The menu example illustrates **Units** in gallons. For liters, select **Liters** in the **Configuration** menu. When in **Control** mode, liters are represented by **P/L** on the display.

### NAVIGATION



Moves up in a menu, toggles between options, or increase a value



Moves down in a menu, toggles between options, or decreases a value



Moves one step back in a menu, when permitted



Sets a value in a menu

Holding the ▲ or ▼ button causes the numbers to change rapidly.

Continued from page 1

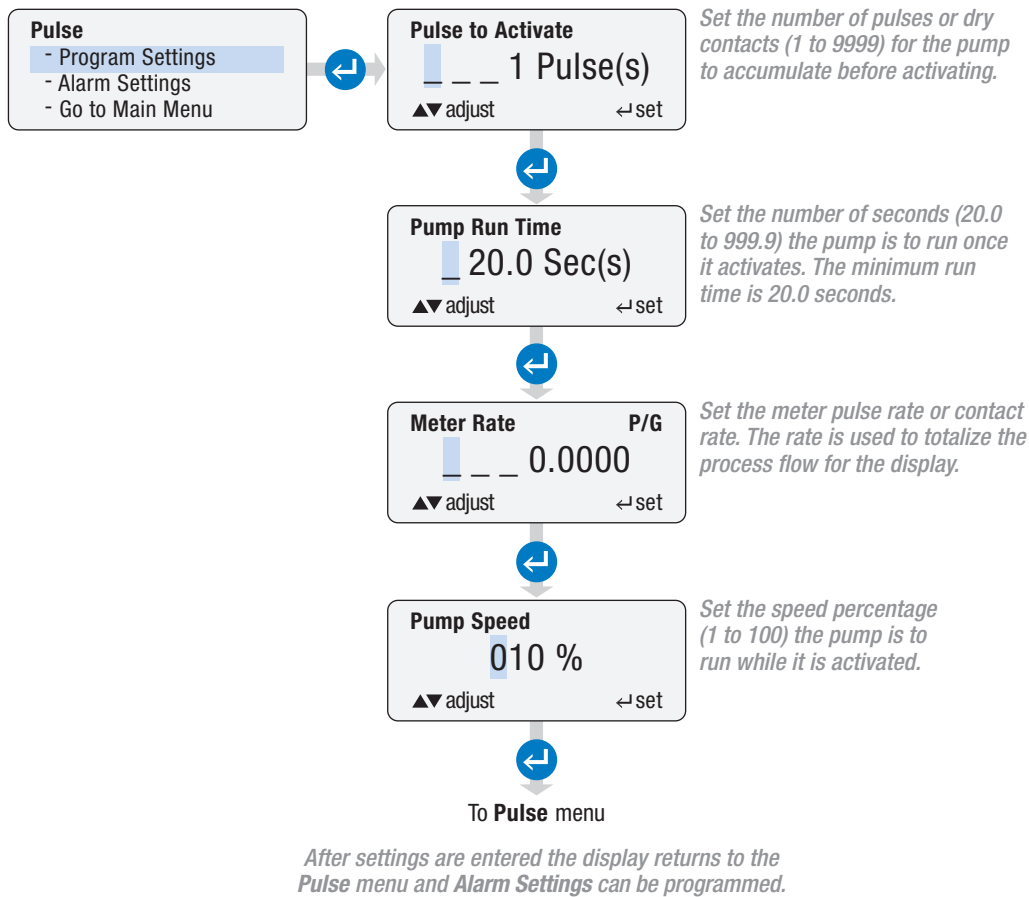

# CONTROL MODES MENU continued

## HALL EFFECT page 1 of 3

Allows user to configure the pump to receive Hall Effect input signals (typically from paddlewheel or turbine flow meters). The pump's speed varies according to a Hall Effect input. The pump is programmed for the flow meter's K factor, process flow range and desired pump output.

The user sets the minimum and maximum process flow rates and the pump speed associated with those two rates, along with the K factor for the meter that is providing the input. The pump will then automatically vary its speed to maintain a dosing proportional to flow based on the input range.

For example, the pump response curve below is for a pump speed of 0% at a minimum process flow of 0.5 gpm and a pump speed of 100% at a maximum process flow rate of 12 gpm.

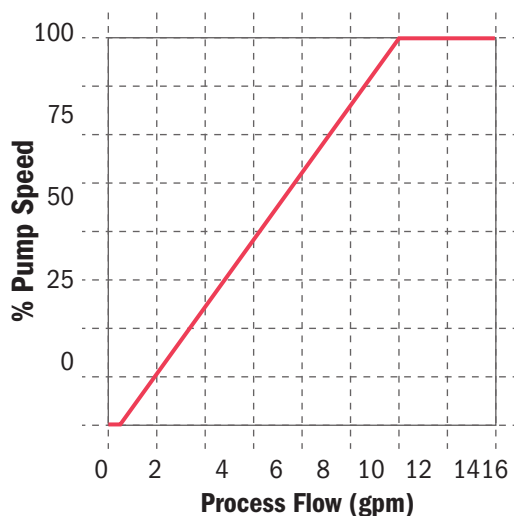

- The pump provides +12VDC to the meter.
- The meter's K factor (pulses per unit of volume) is specified by the meter manufacturer.
- Typically, the meter manufacturer will specify a minimum flow rate for the meter. It is recommended the pump minimum process flow rate setting is not set below this point.

# CONTROL MODES MENU continued

## HALL EFFECT page 2 of 3

The menu example illustrates **Units** in gallons. For liters, select **Liters** in the **Configuration** menu. When in **Control** mode, liters are represented by **P/L** on the display.

### NAVIGATION



Moves up in a menu, toggles between options, or increase a value



Moves down in a menu, toggles between options, or decreases a value



Moves one step back in a menu, when permitted



Sets a value in a menu

Holding the ▲ or ▼ button causes the numbers to change rapidly.

To enter the **Hall Effect** sub-menu, highlight “**Hall Effect**” in the **Control Mode** menu and press **ENTER**.

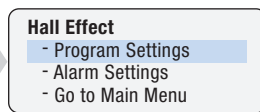
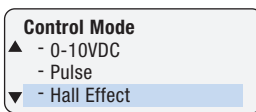

Set the meter K factor.

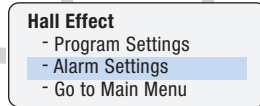

Continue to page 3

After completing the **Program Settings**, select “**Alarm Settings**” and press **ENTER** to go to the **Alarm**

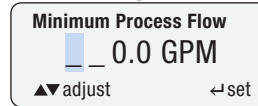

Set the minimum process flow rate at which the pump is to activate.

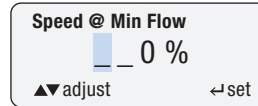
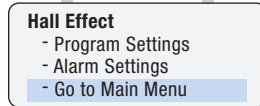

Set the percent pump speed for the minimum process flow rate.



To Main Menu

After completing **Program Settings** and **Alarm Settings**, select “**Go To Main Menu**” and press **ENTER** to return to the **Main Menu**.

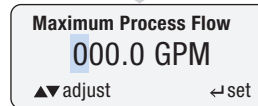

Set the maximum process flow rate.

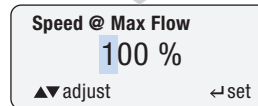

Set the percent pump speed for the maximum process flow rate.



To Hall Effect menu

After the settings are entered, the display returns to **Hall Effect** menu and **Alarm Settings** can be programmed.



# CONTROL MODES MENU continued

## HALL EFFECT page 3 of 3

**CAUTION** A process flow that exceeds the maximum programmed flow rate will lead to incorrect dosing. It is recommended that the user set the high flow alarm. Alarms activate when settings are exceeded.

### NAVIGATION



Moves up in a menu, toggles between options, or increase a value

Holding the ▲ or ▼ button causes the numbers to change rapidly.



Moves down in a menu, toggles between options, or decreases a value



Moves one step back in a menu, when permitted



Sets a value in a menu

Continued from page 2

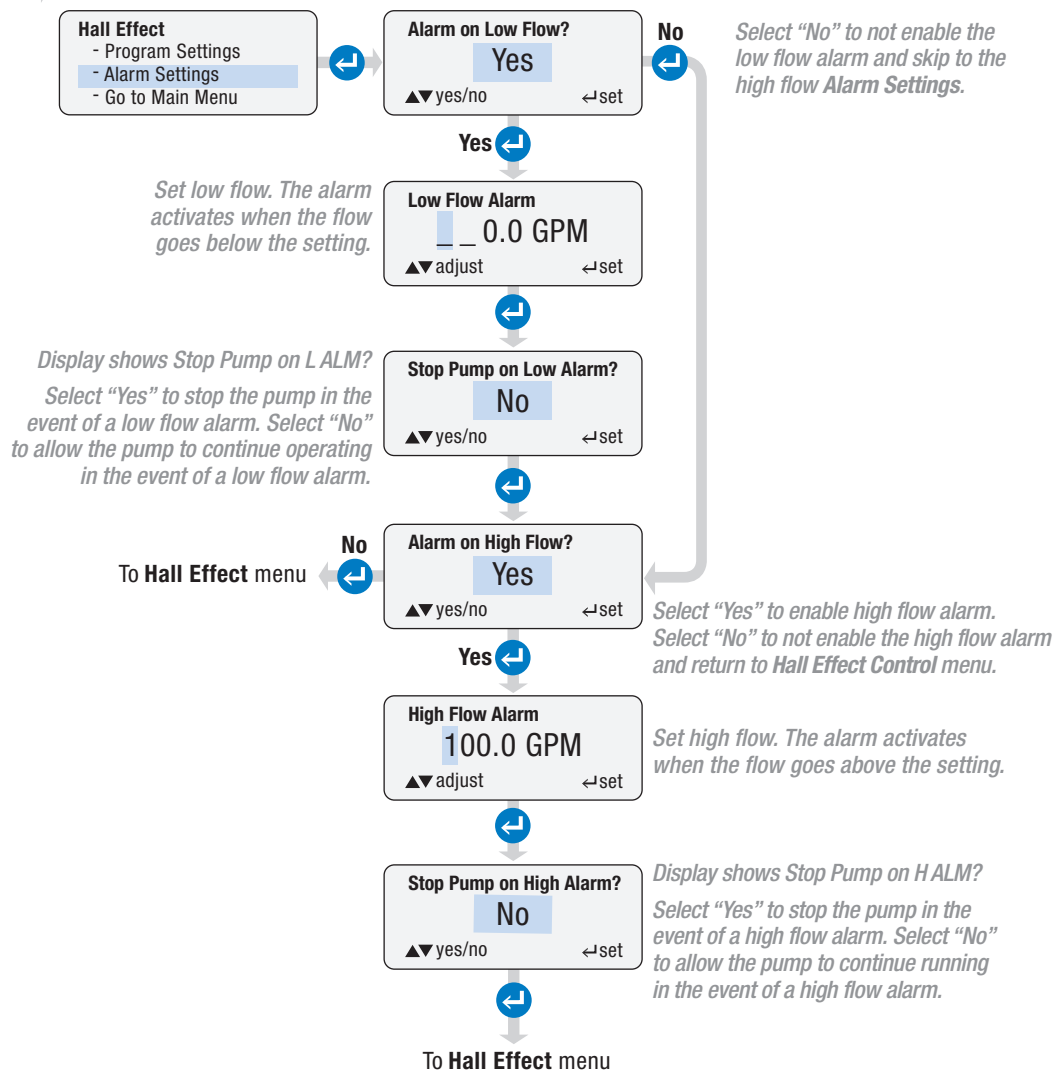

# CONFIGURATION MENU continued

## 7 DAY TIMER page 1 of 3

Allows user to program the pump to turn on and turn off at specific times and specific days. The pump operates with a 24 hour clock format.

- There are 24 independent time events. Each event is individually programmable through timers #01 - #24.
- Each timer can be programmed:
  - For any combination of days
  - To run from a minimum of 20 seconds to a maximum of 23 hours, 59 minutes, and 59 seconds
  - To run at a speed from 1% to 100%
- Each programmed event is contained within 24 hours (from 00:00:00 to 23:59:59). The time for an event cannot exceed 23:59:59.
- By default, all timers are disabled. After programming a timer, it must be enabled in order to run.
- Only programmed timers can be enabled.
- The user can return at any time to the 7 Day Timer menu and individually enable or disable the timers to customize their timer events.
- The pump uses a battery to maintain the clock when power is removed.
- The timer programs entered by the user are stored in non-volatile memory.

# CONTROL MODES MENU continued

## 7 DAY TIMER page 2 of 3

### NAVIGATION



Moves up in a menu, toggles between options, or increase a value



Moves down in a menu, toggles between options, or decreases a value



Moves one step back in a menu, when permitted



Sets a value in a menu

Holding the ▲ or ▼ button causes the numbers to change rapidly.

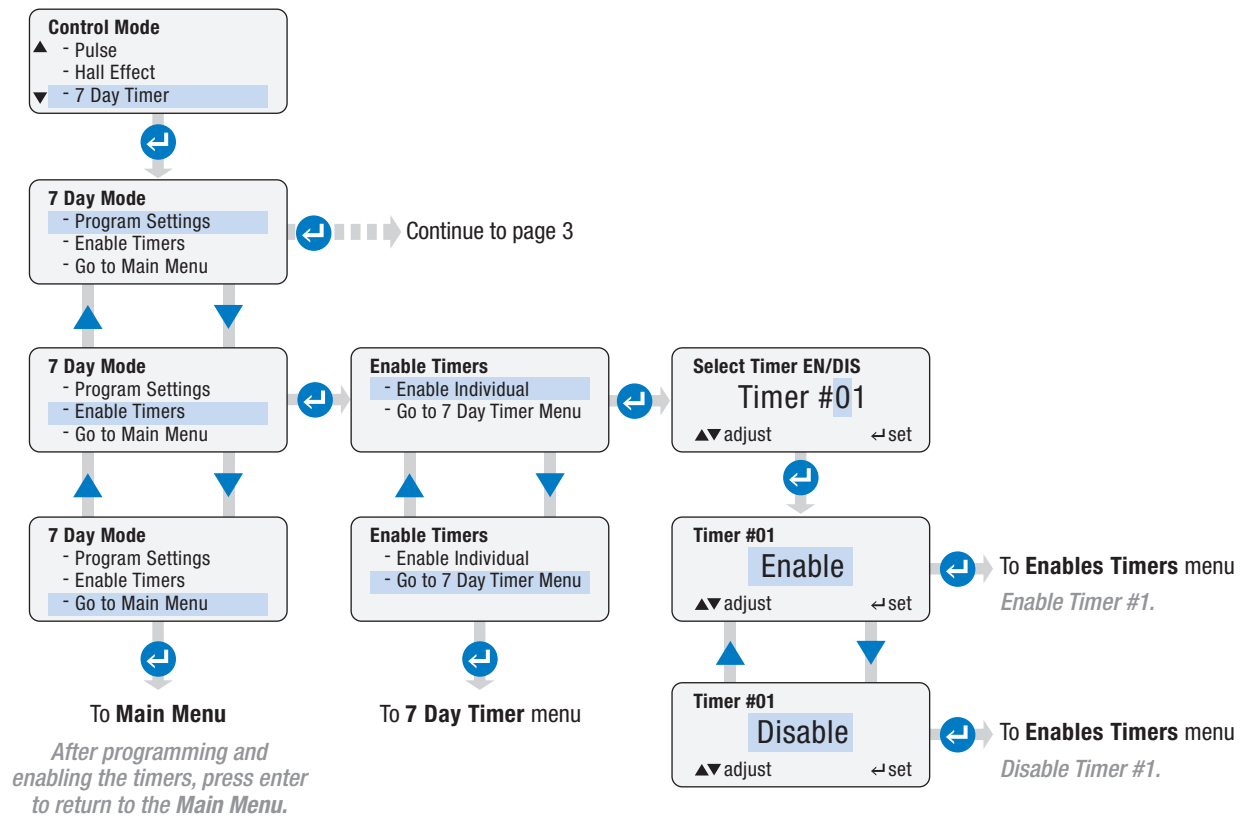

# CONTROL MODES MENU continued

## 7 Day Timer page 3 of 3

The timer utilizes a 24 hour format.

### NAVIGATION



Moves up in a menu, toggles between options, or increase a value

Holding the ▲ or ▼ button causes the numbers to change rapidly.



Moves down in a menu, toggles between options, or decreases a value



Moves one step back in a menu, when permitted



Sets a value in a menu

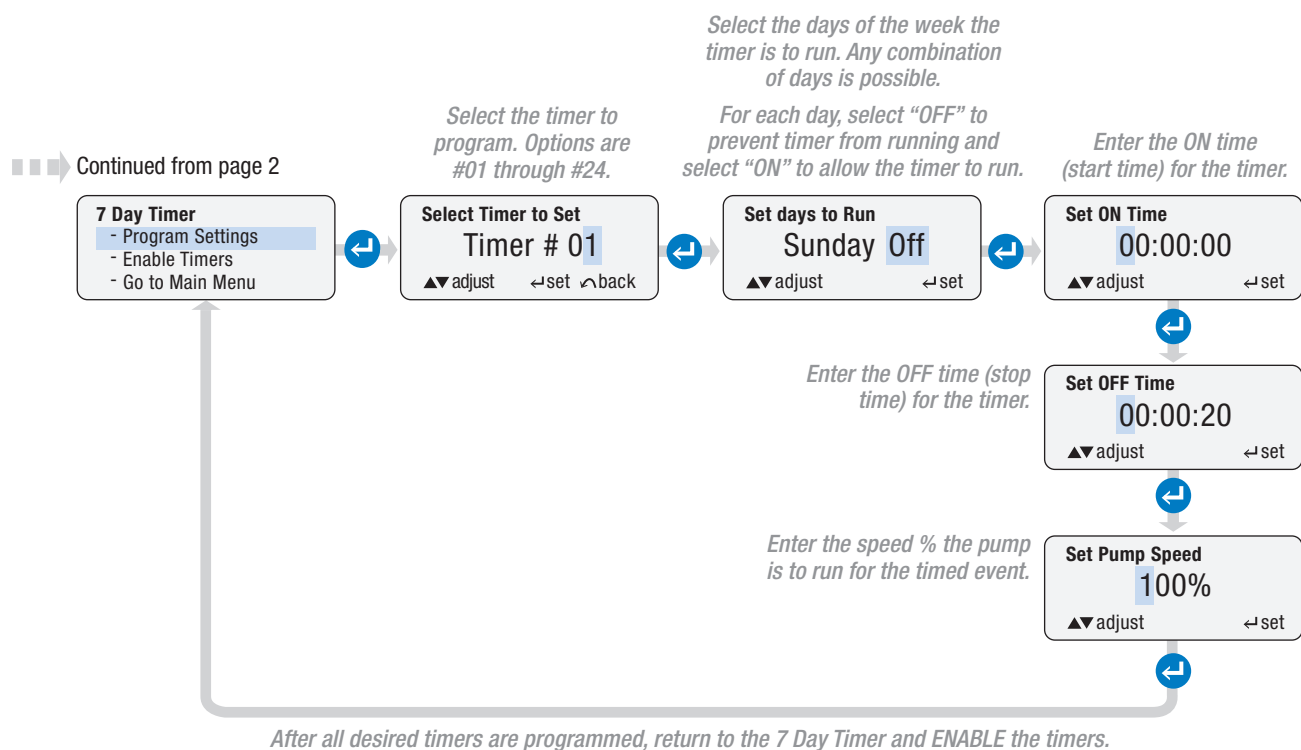

# CONTROL MODES MENU continued

## PPM FEED page 1 of 6

Allows user to configure the pump to automatically dose a specific ppm of solution into the process flow.

PPM feed has two options: **Constant Flow, Flow Switch** and **Variable Flow, Hall Effect**.

**Constant Flow, Flow Switch:** The Constant Flow, Flow Switch option is used with process systems with a constant flow. The pump accepts a dry contact or an open collector signal to trigger the pump.

Program the pump with the:

- Process flow rate (GPM or LPM selected in the **Units** submenu of **Configuration**)
- Chemical concentration %
- Desired PPM dosing rate of the chemical

The pump uses the following equations to calculate the required speed:

- In GPD

$$\text{Pump Output Required (GPD)} = \frac{\text{Process GPM} \times \text{Feed Rate PPM} \times 1440}{\text{Chemical Concentration \%} \times 10,000 \times \text{Specific Gravity}}$$

$$\text{Pump Speed (\%)} = \frac{\text{Pump Output Required (GPD)} \times 100}{\text{Max Pump Flow (GPD)}}$$

- In LPD

$$\text{Pump Output Required (LPD)} = \frac{\text{Process LPM} \times \text{Feed Rate PPM} \times 1440}{\text{Chemical Concentration \%} \times 10,000 \times \text{Specific Gravity}}$$

$$\text{Pump Speed (\%)} = \frac{\text{Pump Output Required (LPD)} \times 100}{\text{Max Pump Flow (LPD)}}$$

- When the pump receives an input signal, it runs at the speed calculated to dose the PPM level programmed.

# CONTROL MODES MENU continued

## PPM FEED – CONSTANT FLOW, FLOW SWITCH page 2 of 6

### NAVIGATION



Moves up in a menu, toggles between options, or increase a value

Holding the ▲ or ▼ button causes the numbers to change rapidly.



Moves down in a menu, toggles between options, or decreases a value



Moves one step back in a menu, when permitted



Sets a value in a menu

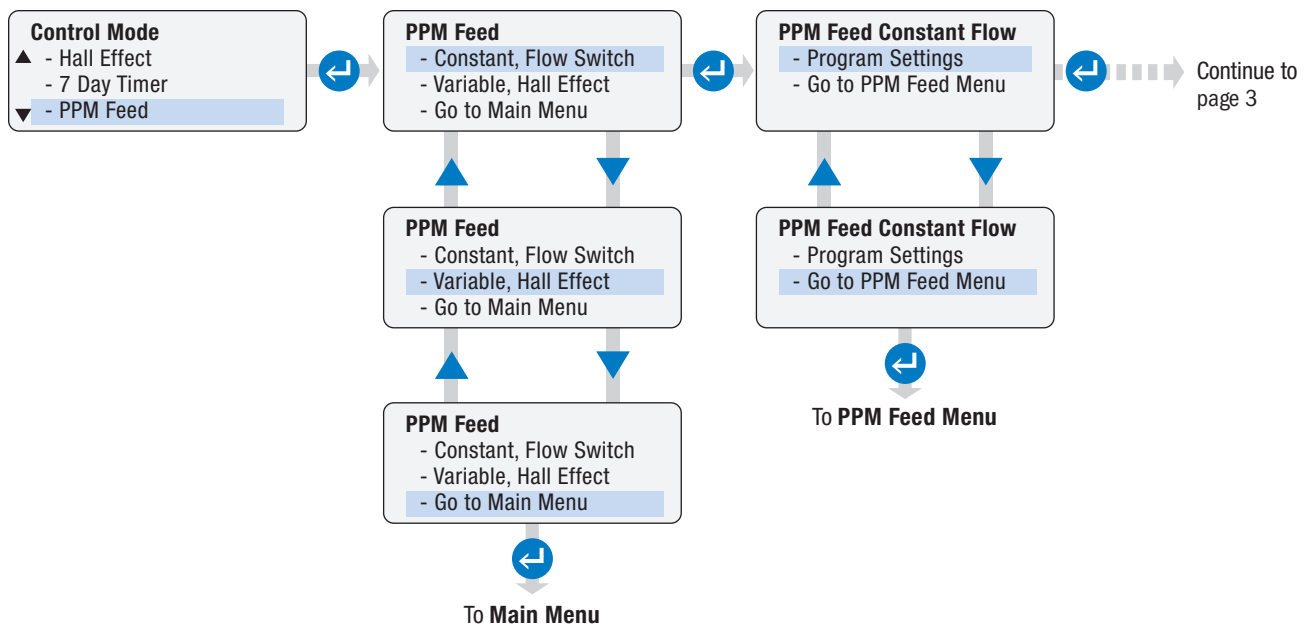

*After completing Program Settings, select "Go To Main Menu" and press ENTER to return to the Main Menu.*

# CONTROL MODES MENU continued

## PPM FEED – CONSTANT FLOW, FLOW SWITCH page 3 of 6

### NAVIGATION



Moves up in a menu, toggles between options, or increase a value

Holding the ▲ or ▼ button causes the numbers to change rapidly.



Moves down in a menu, toggles between options, or decreases a value



Moves one step back in a menu, when permitted



Sets a value in a menu

Continued from page 2

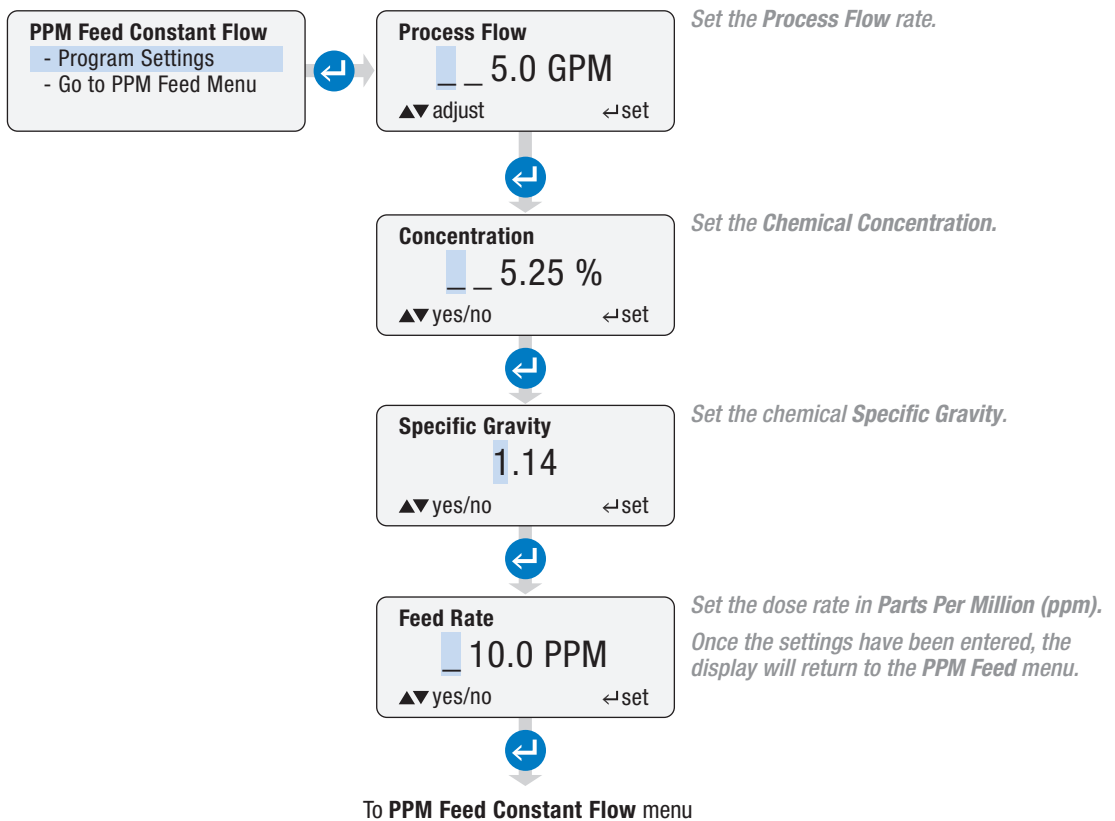

## CONTROL MODES MENU continued

### PPM FEED – VARIABLE FLOW, HALL EFFECT page 4 of 6

The Variable Flow, Hall Effect option is used with process systems with a variable flow. The pump accepts a hall effect input from a flow meter (typically, a paddlewheel or turbine type meter).

Program the pump with the:

- Meter K factor
- Process minimum and maximum flow rate (GPM or LPM selected in the **Units** submenu of **Configuration**)
- Chemical concentration %
- Specific gravity of the chemical
- Desired PPM dosing rate of the chemical

The pump uses the following equations to calculate the required speed:

- In GPD

$$\text{Pump Output Required (GPD)} = \frac{\text{Process GPM} \times \text{Feed Rate PPM} \times 1440}{\text{Chemical Concentration \%} \times 10,000 \times \text{Specific Gravity}}$$

$$\text{Pump Speed (\%)} = \frac{\text{Pump Output Required (GPD)} \times 100}{\text{Max Pump Flow (GPD)}}$$

- In LPD

$$\text{Pump Output Required (LPD)} = \frac{\text{Process LPM} \times \text{Feed Rate PPM} \times 1440}{\text{Chemical Concentration \%} \times 10,000 \times \text{Specific Gravity}}$$

$$\text{Pump Speed (\%)} = \frac{\text{Pump Output Required (LPD)} \times 100}{\text{Max Pump Flow (LPD)}}$$



# CONTROL MODES MENU continued

## PPM FEED – VARIABLE FLOW, HALL EFFECT page 5 of 6

**⚠ CAUTION** A process flow that exceeds the maximum programmed flow rate will lead to incorrect dosing. It is recommended to the high flow alarm. Alarms activate when settings are exceeded.

### NAVIGATION



Moves up in a menu, toggles between options, or increase a value

Holding the ▲ or ▼ button causes the numbers to change rapidly.



Moves down in a menu, toggles between options, or decreases a value



Moves one step back in a menu, when permitted



Sets a value in a menu

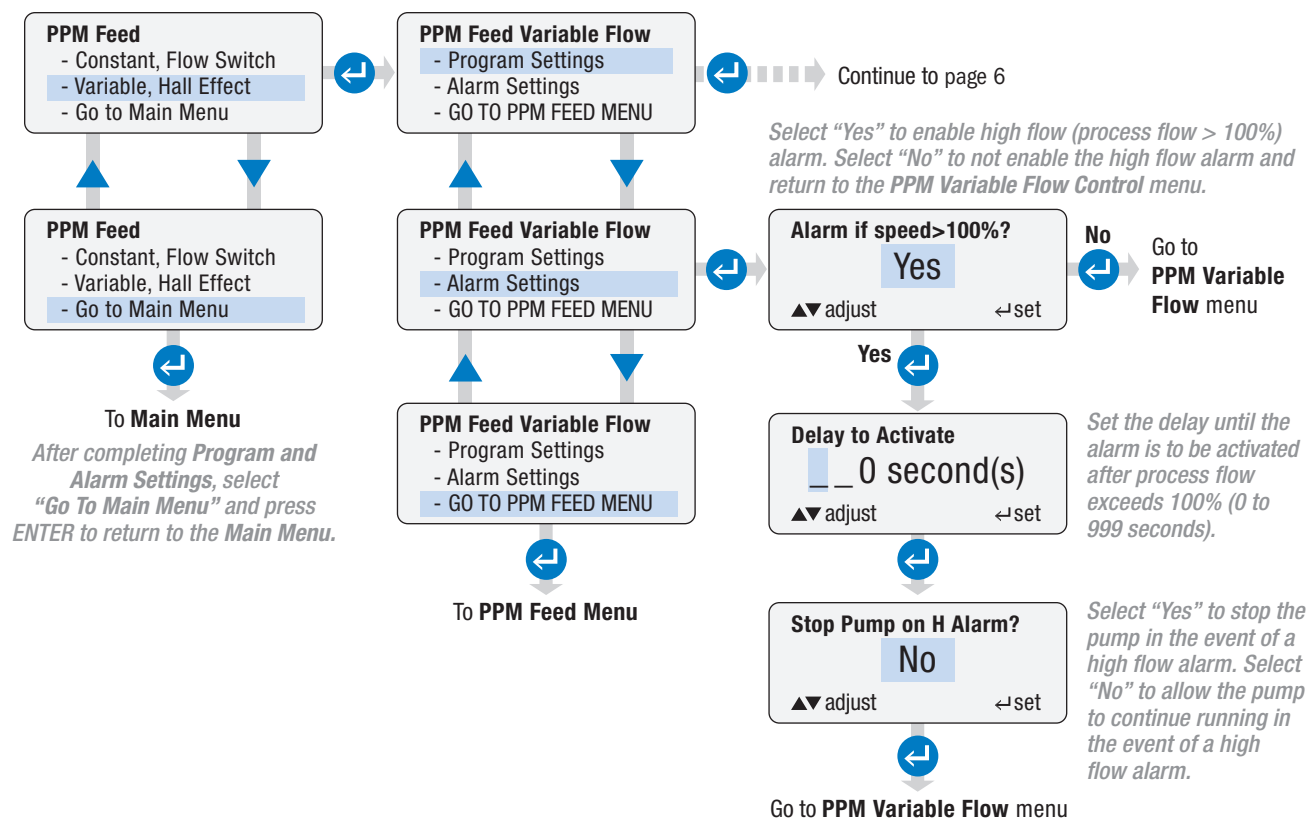

# CONTROL MODES MENU continued

## PPM FEED – VARIABLE FLOW, HALL EFFECT page 6 of 6

- The pump provides +12VDC to the meter.
- The meter's K factor (pulses per unit of volume) is specified by the meter manufacturer.
- Typically, the meter manufacturer specifies a minimum flow rate for the meter. The pump minimum process flow rate setting should not be set below the meter manufacturer's recommendation.

### NAVIGATION



Moves up in a menu, toggles between options, or increase a value



Moves down in a menu, toggles between options, or decreases a value



Moves one step back in a menu, when permitted



Sets a value in a menu

Holding the ▲ or ▼ button causes the numbers to change rapidly.

Continued from page 5

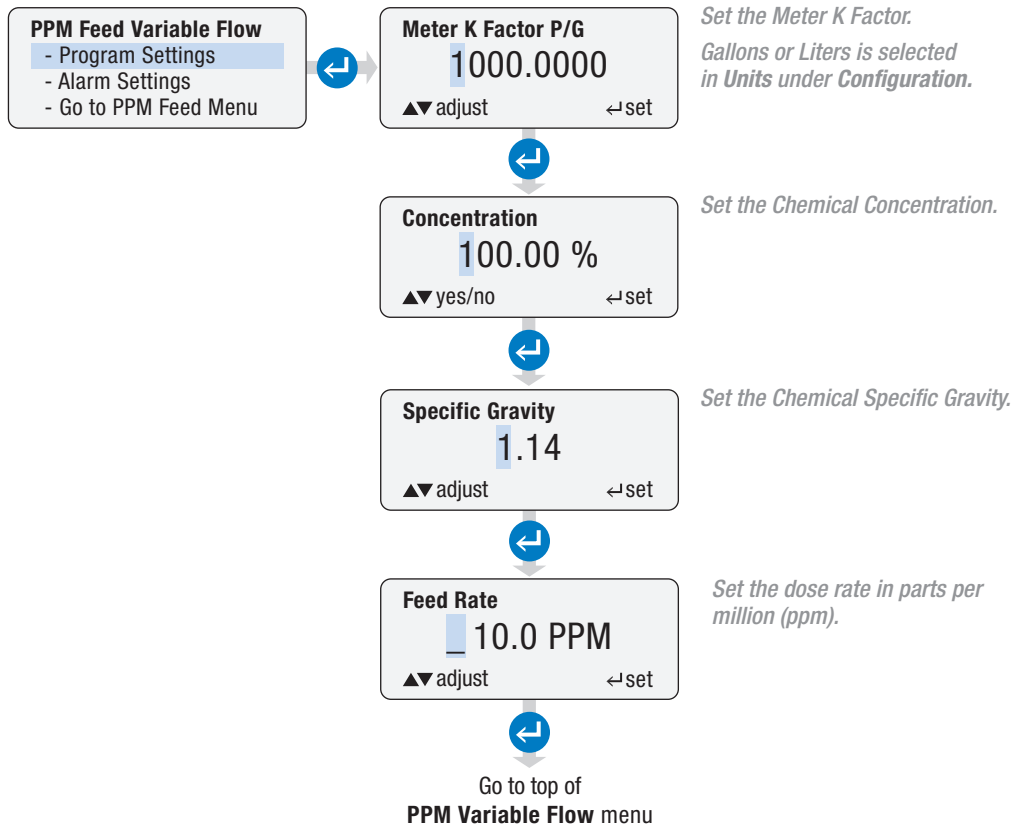

# CONTROL MODES MENU continued

## CYCLE TIMER

Allows user to configure a run time and off time cycle that the pump will continuously repeat.

### NAVIGATION



Moves up in a menu, toggles between options, or increase a value

Holding the ▲ or ▼ button causes the numbers to change rapidly.



Moves down in a menu, toggles between options, or decreases a value



Moves one step back in a menu, when permitted



Sets a value in a menu

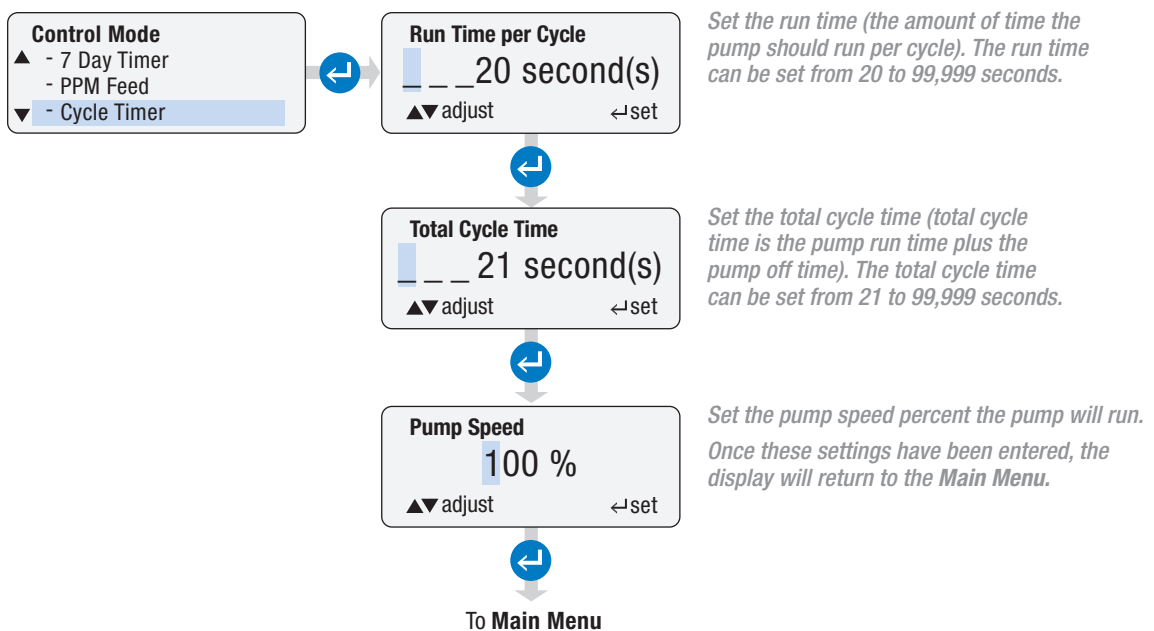

# CONTROL MODES MENU continued

## GO TO MAIN MENU

Allows user to return to **Main Menu**.

### NAVIGATION



Moves up in a menu, toggles between options, or increase a value

Holding the ▲ or ▼ button causes the numbers to change rapidly.



Moves down in a menu, toggles between options, or decreases a value



Moves one step back in a menu, when permitted



Sets a value in a menu

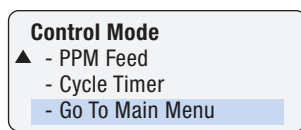

To Main Menu

*To return to the Main Menu, highlight "Go To Main Menu" in the Control Mode menu and press ENTER.*

# OPERATING MODE







## DISPLAYS

After selecting “**Run Pump**” in the **Main Menu** and pressing ENTER, the pump will go into **Operating Mode** and start running based on the programmed settings.

The Operating Display shows the screens available to view while in the **Operating Mode**.

- If a password is set, the pump controls will lock out after 60 seconds if there is no keypad activity.
- To unlock the pump, press ENTER for 2 seconds. The pump will display a prompt to enter a password.

In operating mode, the functions are available when the pump is unlocked or no password is set:

Button	Operating Mode Function	General Function
 <b>UP</b>	Increases the speed percent in the <b>Manual mode</b>	<ul style="list-style-type: none"><li>· Moves up in a menu</li><li>· Toggles between menu options</li><li>· Increases a value</li></ul>
 <b>DOWN</b>	Decreases the speed percent in the <b>Manual mode</b>	<ul style="list-style-type: none"><li>· Moves down in a menu</li><li>· Toggles between options</li><li>· Decreases a value</li></ul>
 <b>PRIME</b>	Runs pump at 100% speed while button is pressed	N/A
 <b>ON/OFF</b>	Turns pump control ON or OFF WARNING: Does not remove power	N/A
 <b>BACK</b>	Cycles the display through the units of output and the control mode specific parameters	Moves one step back in a menu when permitted
 <b>ENTER</b>	Press and hold for 2 seconds to go to the <b>Main Menu</b>	Sets a value

# OPERATING DISPLAY continued

## MANUAL

### NAVIGATION IN OPERATING MODE



#### PRIME

Runs pump at 100% speed while button is pressed



#### ON/OFF

Turns pump control ON or OFF  
**WARNING:** Does not remove power.



#### BACK

Cycles the display through the units of output



#### ENTER

Press and hold for 2 seconds to go to the Main Menu

- When no password is set in Manual Mode, the speed can be adjusted from the operating display via the UP and DOWN buttons.
- If a password is set, the pump controls will lock out after 60 seconds if there is no keypad activity.
- To unlock the pump, press ENTER for 2 seconds. The pump will display a prompt to enter a password.

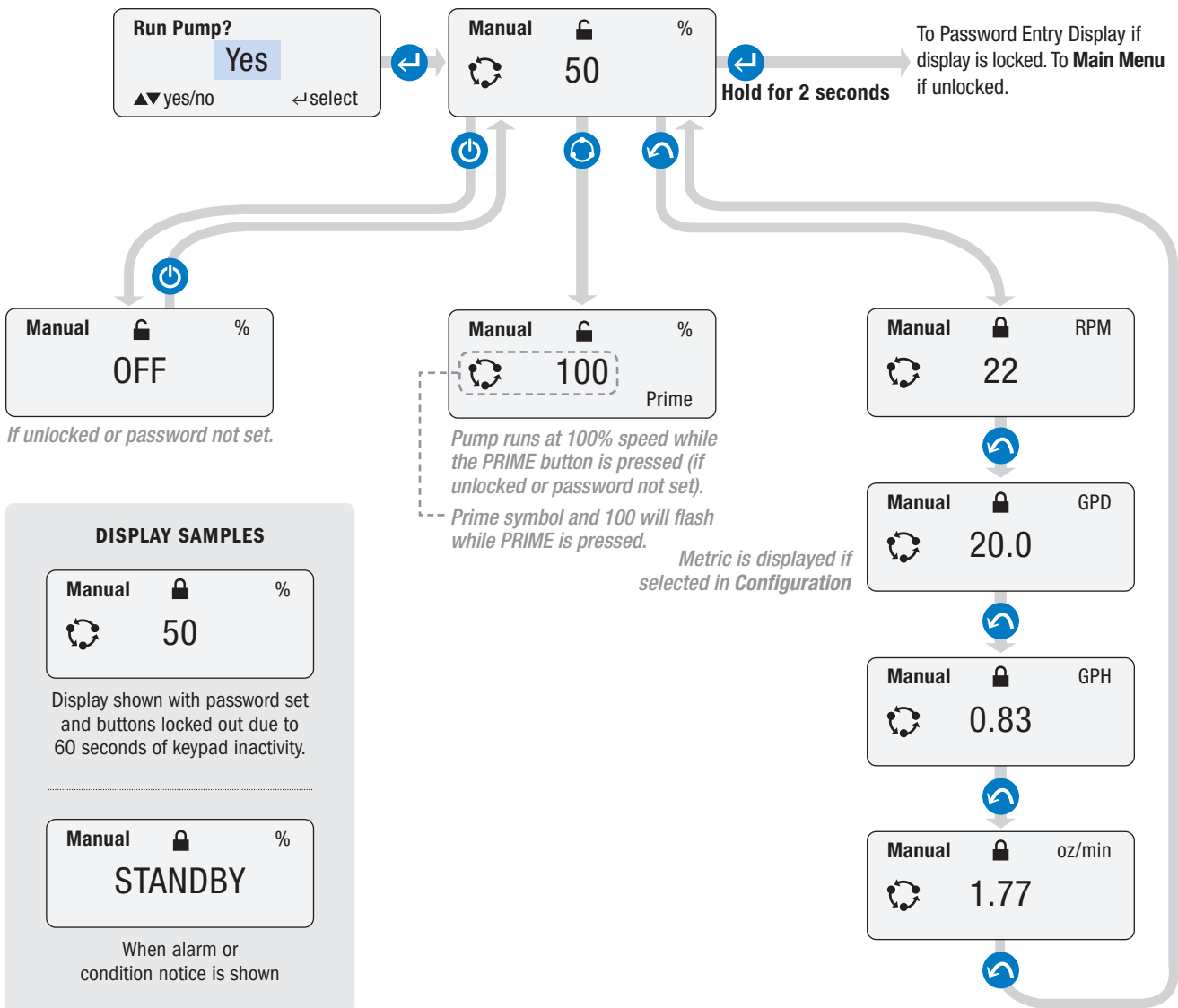

See p64 for information on alarm notifications and clearing of alarms.

# OPERATING DISPLAY continued

## 4-20mA

### NAVIGATION IN OPERATING MODE



**PRIME**  
Runs pump at 100% speed while button is pressed



**ON/OFF**  
Turns pump control ON or OFF  
**WARNING:** Does not remove power.



**BACK**  
Cycles the display through the units of output



**ENTER**  
Press and hold for 2 seconds to go to the Main Menu

- If a password is set, the pump controls will lock out after 60 seconds if there is no keypad activity.
- To unlock the pump, press ENTER for 2 seconds. The pump will display a prompt to enter a password.

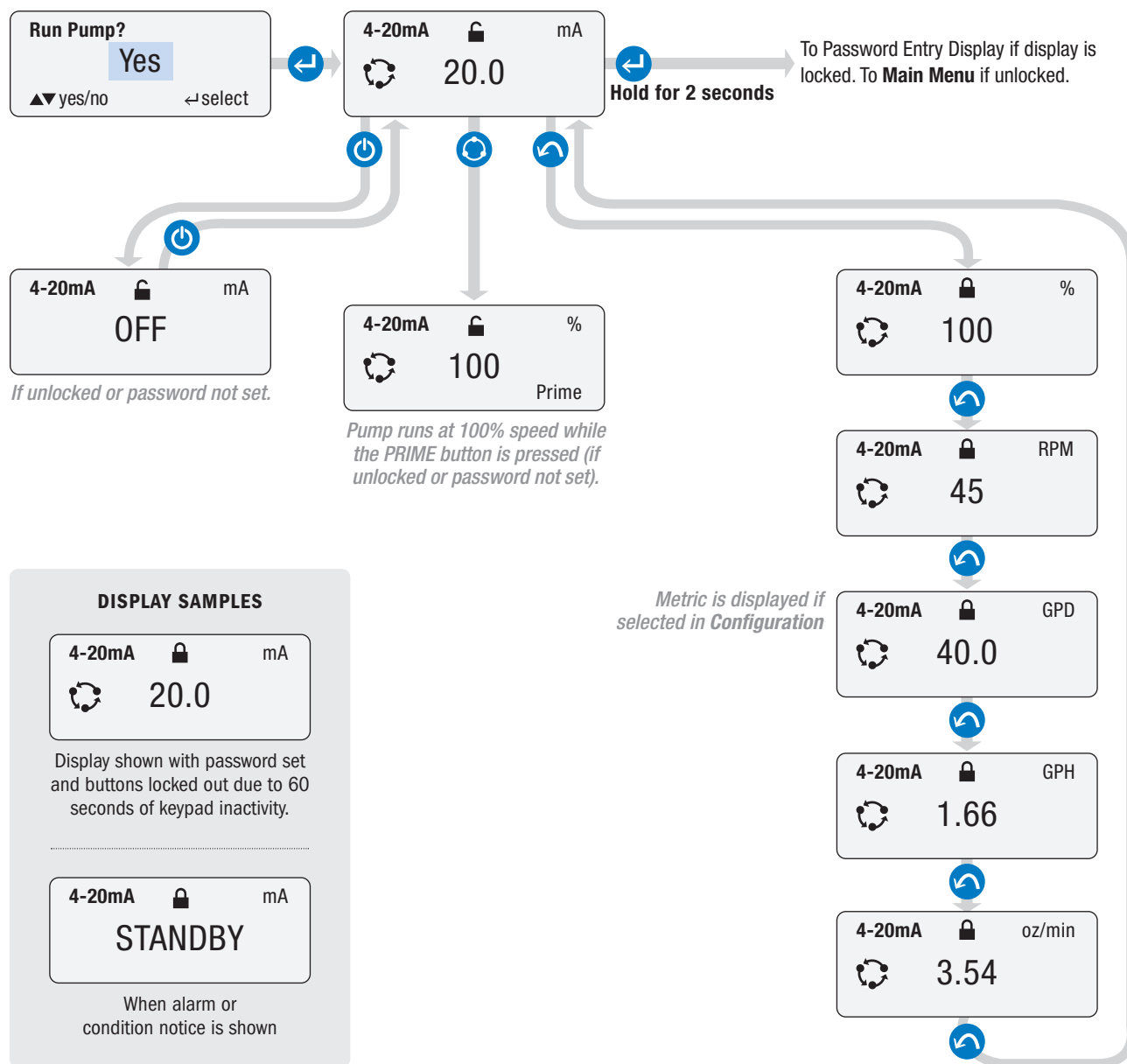

See p64 for information on alarm notifications and clearing of alarms.

# OPERATING DISPLAY continued

## 0-10VDC

### NAVIGATION IN OPERATING MODE



**PRIME**

Runs pump at 100% speed while button is pressed



**ON/OFF**

Turns pump control ON or OFF  
**WARNING:** Does not remove power.



**BACK**

Cycles the display through the units of output



**ENTER**

Press and hold for 2 seconds to go to the Main Menu

- If a password is set, the pump controls will lock out after 60 seconds if there is no keypad activity.
- To unlock the pump, press ENTER for 2 seconds. The pump will display a prompt to enter a password.

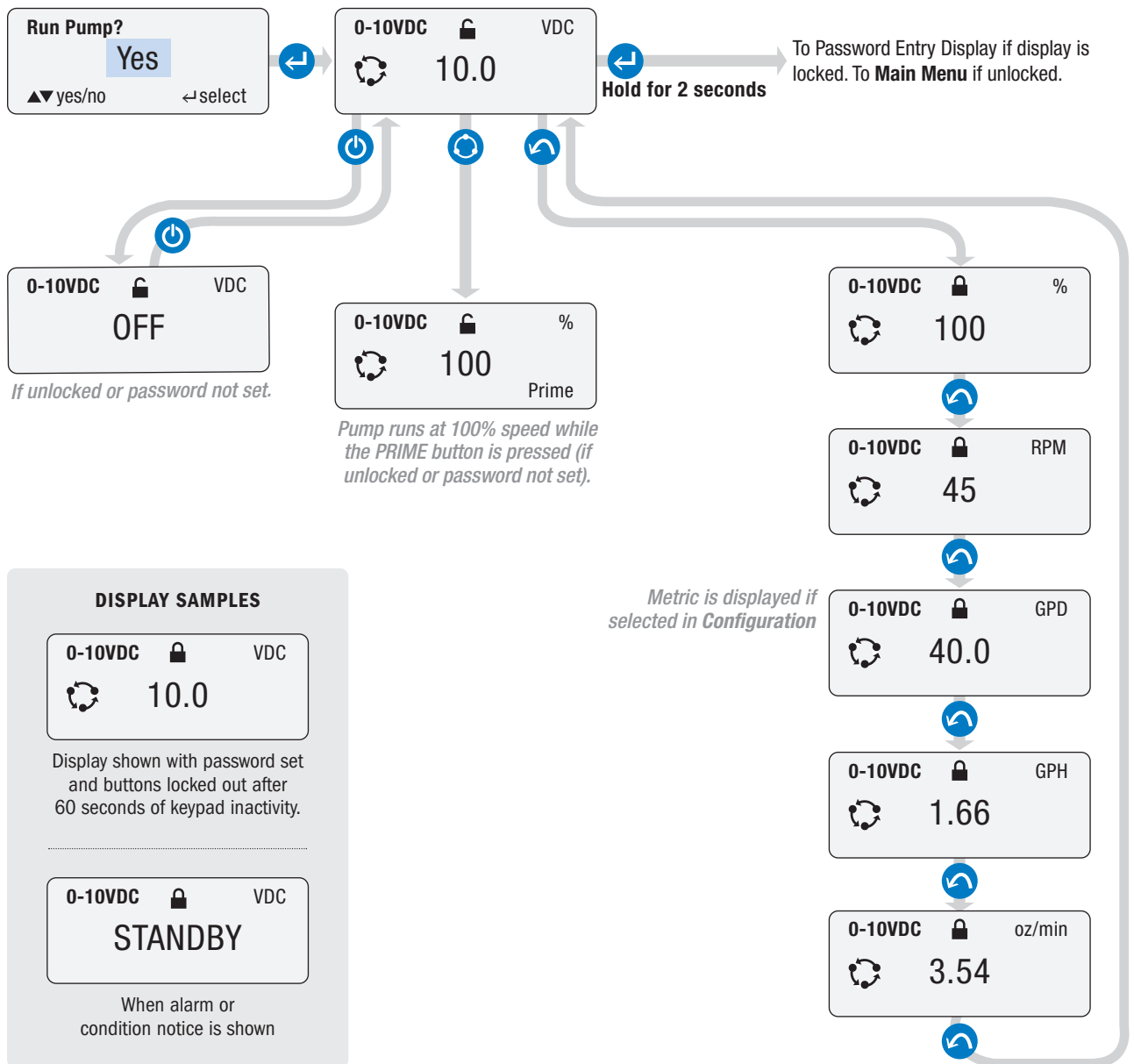

See p64 for information on alarm notifications and clearing of alarms.



# OPERATING DISPLAY continued

## PULSE

### NAVIGATION IN PULSE MODE

#### PRIME

Runs pump at 100% speed while button is pressed

#### ON/OFF

Turns pump control ON or OFF  
WARNING: Does not remove power.

#### BACK

Cycles the display through the units of output and total process flow (gallons or liters)

#### ENTER

Press and hold for 2 seconds to go to the Main Menu

- If a password is set, the pump controls will lock out after 60 seconds if there is no keypad activity.
- To unlock the pump, press ENTER for 2 seconds. The pump will display a prompt to enter a password.

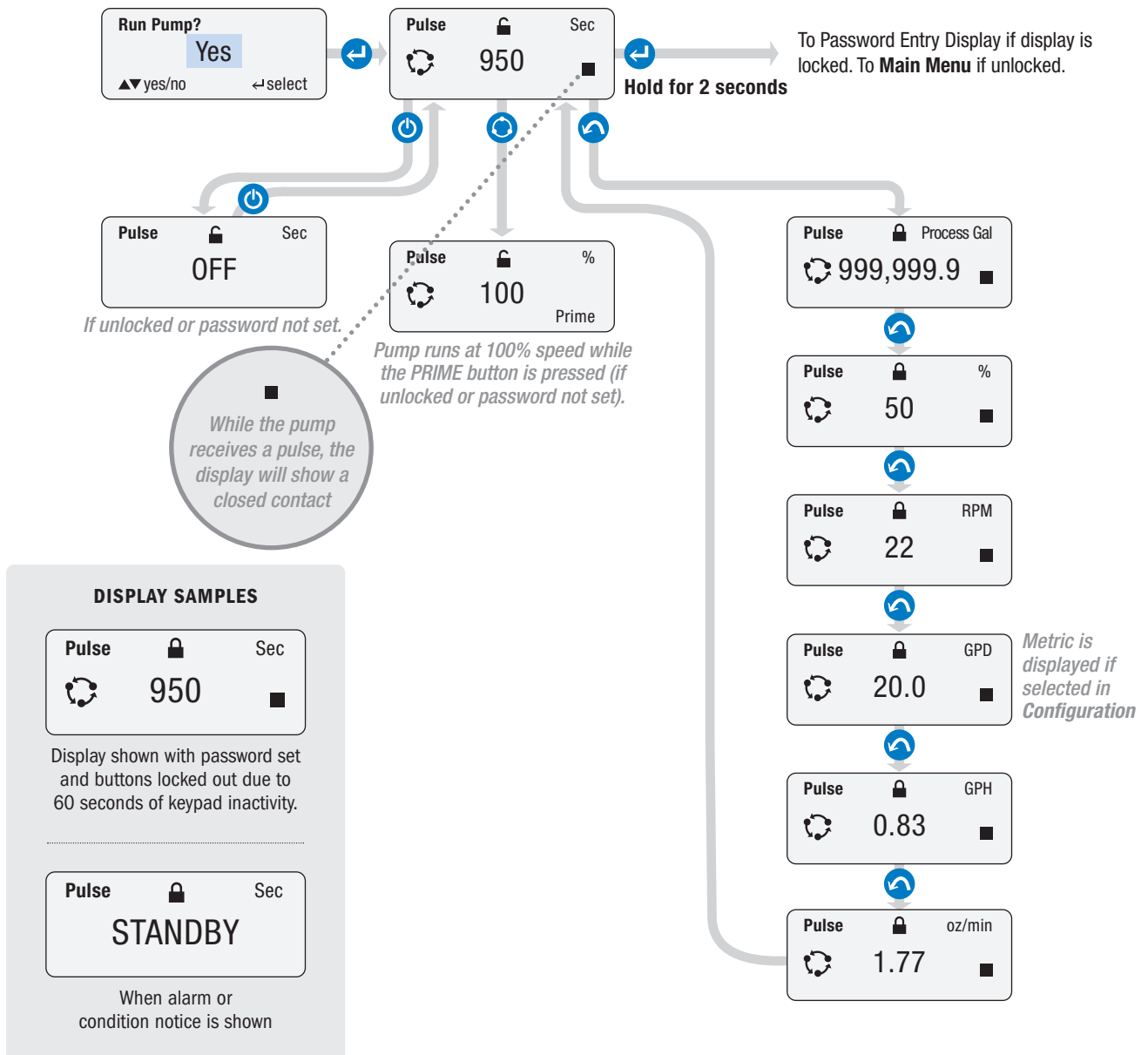

See p64 for information on alarm notifications and clearing of alarms.

# OPERATING DISPLAY continued

## HALL EFFECT

### NAVIGATION IN HALL EFFECT MODE



#### PRIME

Runs pump at 100% speed while button is pressed



#### ON/OFF

Turns pump control ON or OFF  
WARNING: Does not remove power.



#### BACK

Cycles the display through the units of output, current process flow, and total process flow (gallons or liters, GPM or LPM).



#### ENTER

Press and hold for 2 seconds to go to the Main Menu

- If a password is set, the pump controls will lock out after 60 seconds if there is no keypad activity.
- To unlock the pump, press ENTER for 2 seconds. The pump will display a prompt to enter a password.

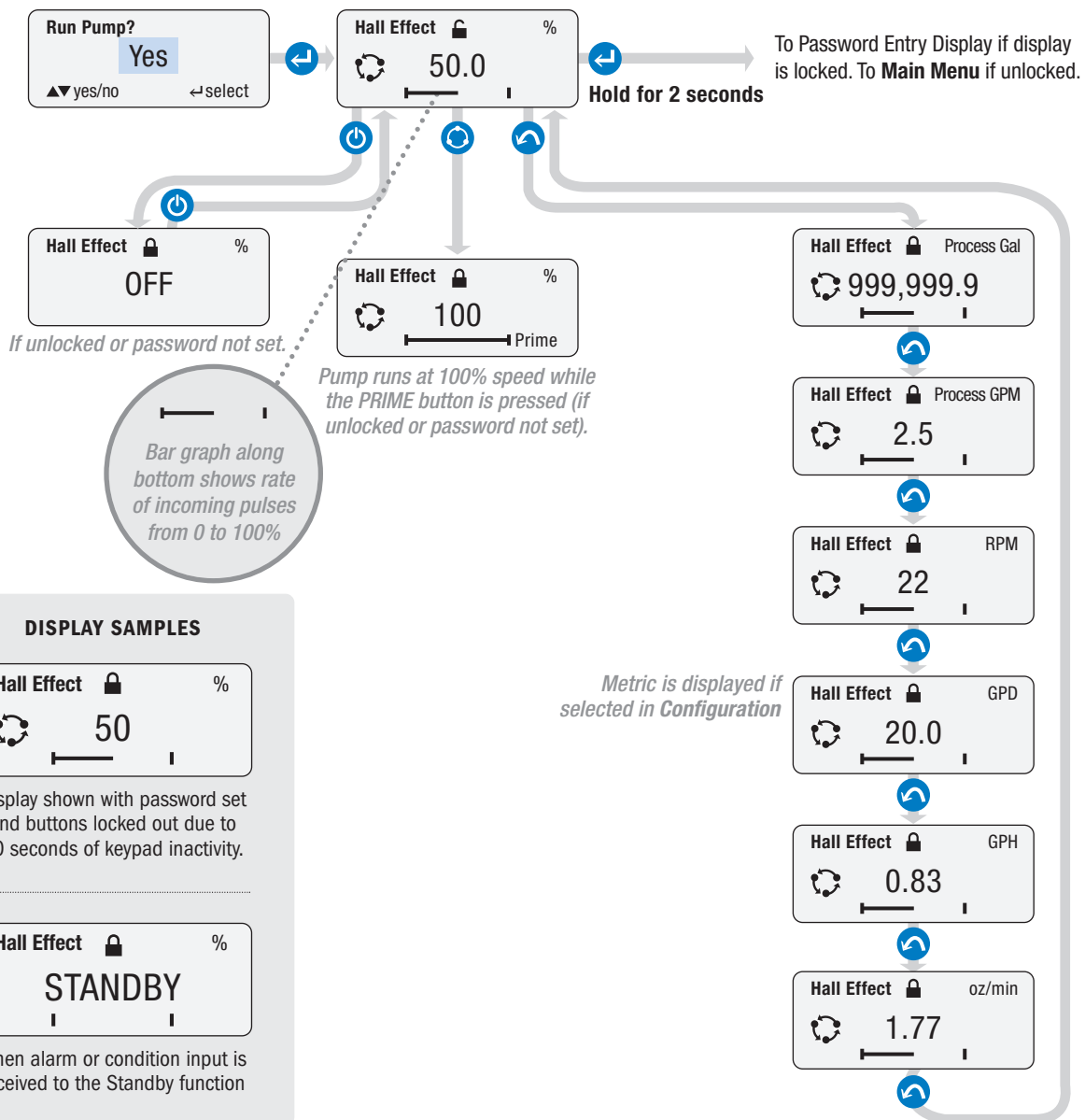

### DISPLAY SAMPLES



Display shown with password set and buttons locked out due to 60 seconds of keypad inactivity.



When alarm or condition input is received to the Standby function

See p64 for information on alarm notifications and clearing of alarms.

# OPERATING DISPLAY continued

## 7 DAY TIMER

### NAVIGATION IN 7 DAY TIMER MODE

#### PRIME

Runs pump at 100% speed while button is pressed

#### ON/OFF

Turns pump control ON or OFF  
WARNING: Does not remove power.

#### BACK

Cycles the display through the units of output and the next events

#### ENTER

Press and hold for 2 seconds to go to the Main Menu

- If a password is set, the pump controls will lock out after 60 seconds if there is no keypad activity.
- To unlock the pump, press ENTER for 2 seconds. The pump will display a prompt to enter a password.

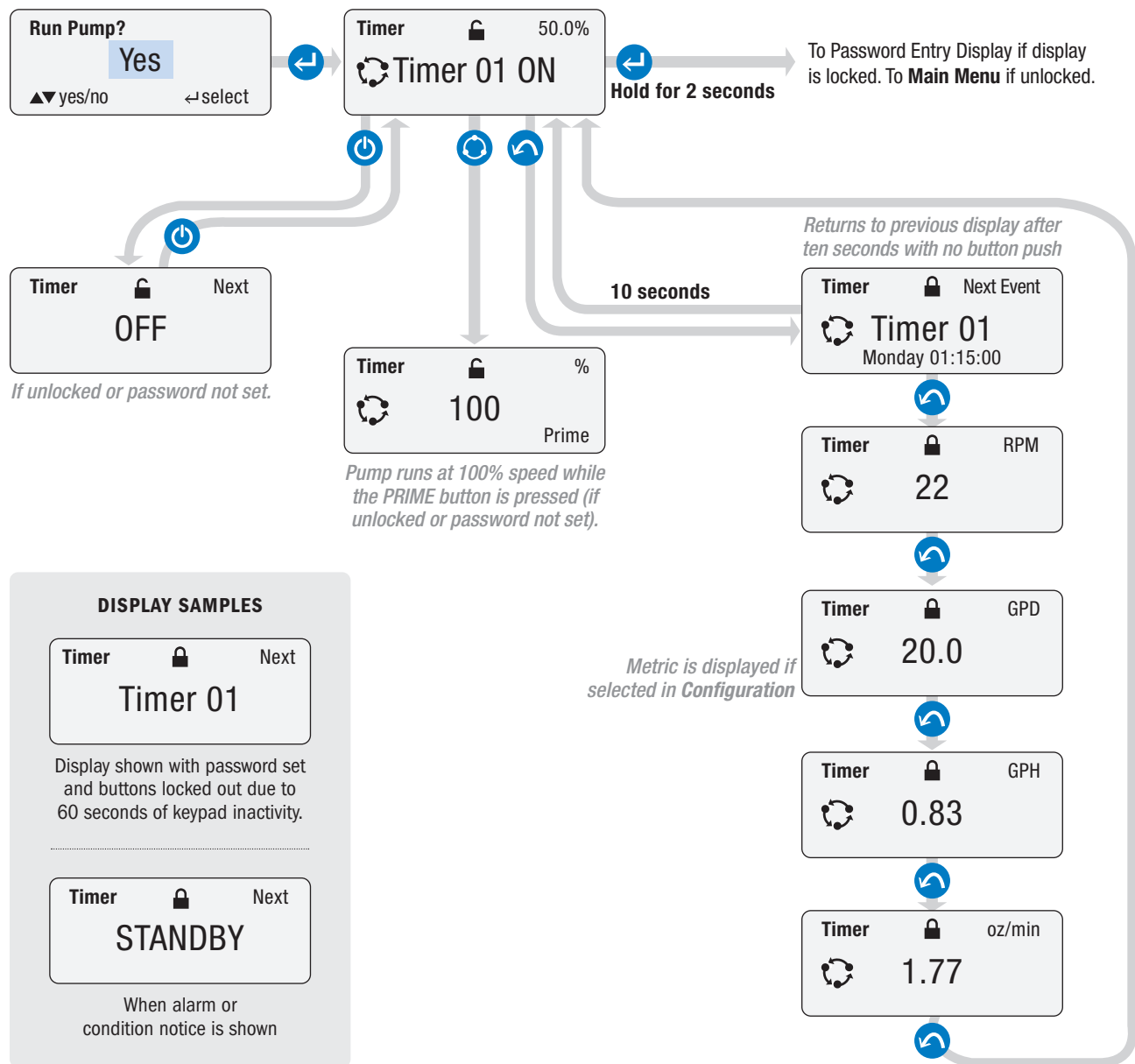

### DISPLAY SAMPLES

**Timer** Next  
Timer 01

Display shown with password set and buttons locked out due to 60 seconds of keypad inactivity.

**Timer** Next  
STANDBY

When alarm or condition notice is shown

See p64 for information on alarm notifications and clearing of alarms.

# OPERATING DISPLAY continued

## PPM FEED, VARIABLE FLOW

### NAVIGATION IN PPM, VARIABLE FLOW MODE



**PRIME**  
Runs pump at 100% speed while button is pressed



**ON/OFF**  
Turns pump control ON or OFF  
**WARNING:** Does not remove power.



**BACK**  
Cycles the display through the units of output, current process flow, and total process flow (gallons or liters, GPM or LPM)



**ENTER**  
Press and hold for 2 seconds to go to the Main Menu

- If a password is set, the pump controls will lock out after 60 seconds if there is no keypad activity.
- To unlock the pump, press ENTER for 2 seconds. The pump will display a prompt to enter a password.

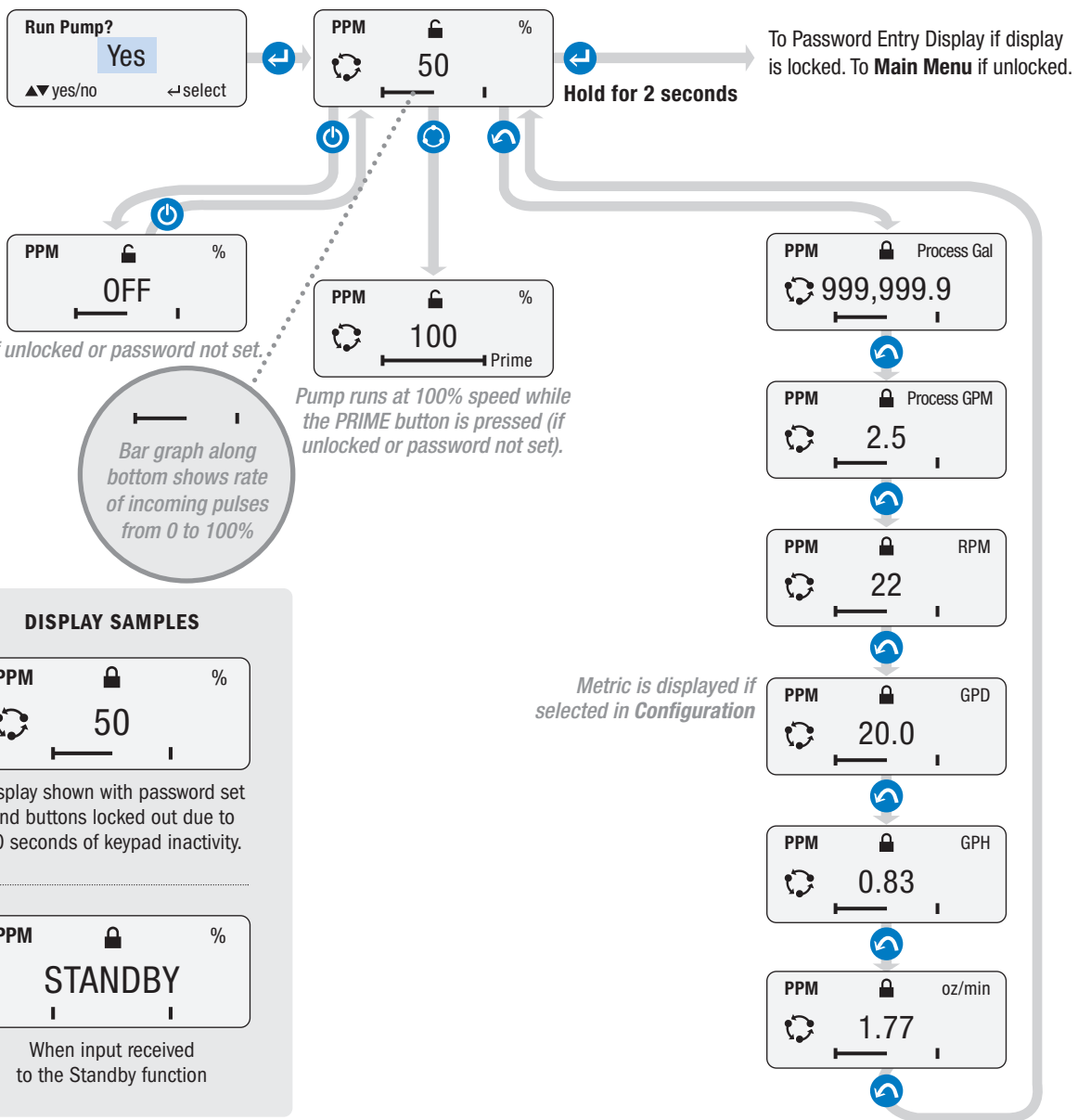

### DISPLAY SAMPLES



Display shown with password set and buttons locked out due to 60 seconds of keypad inactivity.



When input received to the Standby function

See p64 for information on alarm notifications and clearing of alarms.

# OPERATING DISPLAY continued

## PPM FEED, CONSTANT FLOW

### NAVIGATION IN OPERATING MODE

#### PRIME

Runs pump at 100% speed while button is pressed

#### ON/OFF

Turns pump control ON or OFF  
WARNING: Does not remove power.

#### BACK

Cycles the display through the units of output

#### ENTER

Press and hold for 2 seconds to go to the Main Menu

- If a password is set, the pump controls will lock out after 60 seconds if there is no keypad activity.
- To unlock the pump, press ENTER for 2 seconds. The pump will display a prompt to enter a password.

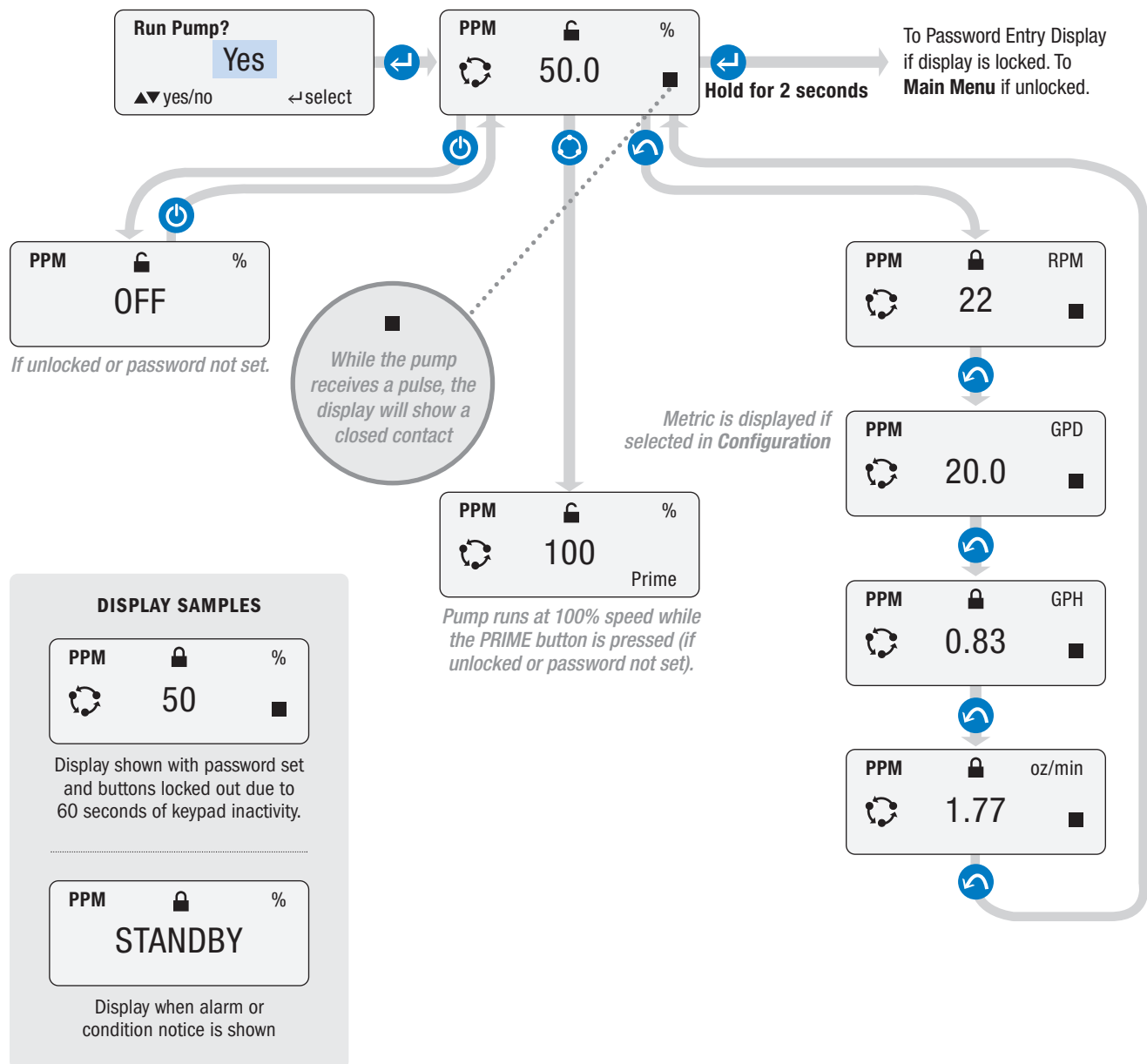

See p64 for information on alarm notifications and clearing of alarms.

# OPERATING DISPLAY continued

## CYCLE TIMER

### NAVIGATION IN OPERATING MODE



#### PRIME

Runs pump at 100% speed while button is pressed



#### ON/OFF

Turns pump control ON or OFF  
WARNING: Does not remove power.



#### BACK

Cycles the display through the units of output



#### ENTER

Press and hold for 2 seconds to go to the Main Menu

- If a password is set, the pump controls will lock out after 60 seconds if there is no keypad activity.
- To unlock the pump, press ENTER for 2 seconds. The pump will display a prompt to enter a password.

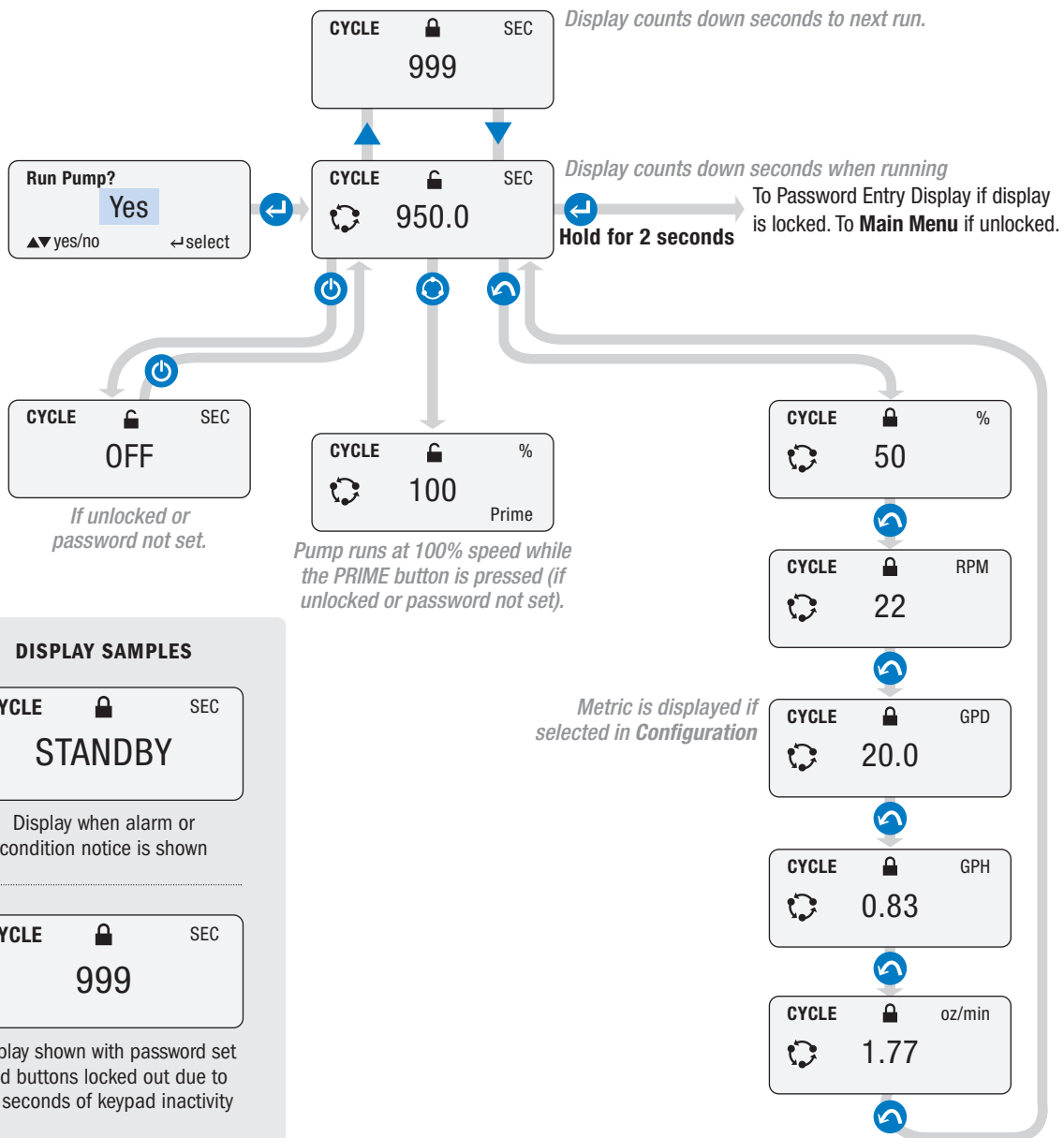

See p64 for information on alarm notifications and clearing of alarms.

# OPERATING DISPLAY continued

## ENTER PASSWORD

### NAVIGATION IN OPERATING MODE



#### PRIME

Runs pump at 100% speed while button is pressed



#### ON/OFF

Turns pump control ON or OFF  
WARNING: Does not remove power.



#### BACK

Cycles the display through the units of output



#### ENTER

Press and hold for 2 seconds to go to the Main Menu

- If a password is set, the pump controls will lock out after 60 seconds if there is no keypad activity.
- To unlock the pump, press ENTER for 2 seconds. The pump will display a prompt to enter a password.

This example shows the **MANUAL** operating display. The password steps are the same from any operating display.

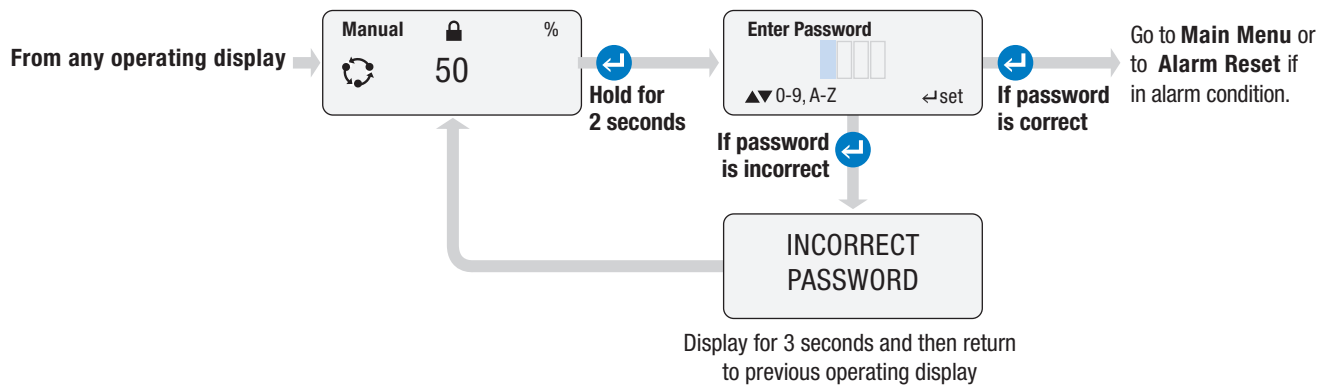

# OPERATING DISPLAY continued

## DISPLAY ALARMS

Refer to p22 **CONFIGURATION MENU**: Outputs (Relay) for information on pump conditions and alarms. Refer to p10 for a summary chart on display alarms and output relays.

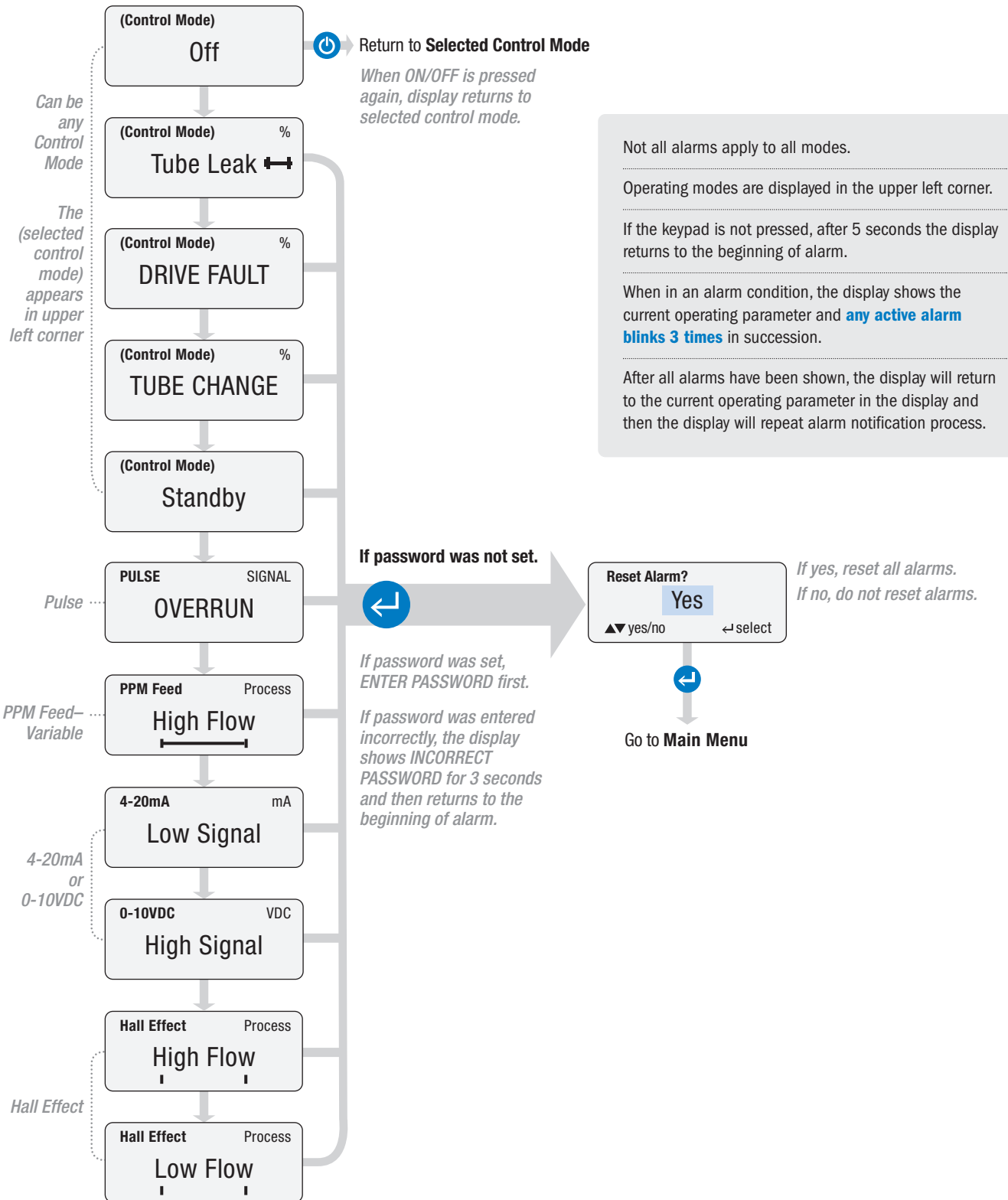



# CONNECTIONS

## USER INTERFACE CONNECTIONS

The input and output connection terminals are located at the rear of the pump. To access it, unplug the pump and remove the signal cover by taking out the Phillips head screws that secure it in place.

Prepare the signal cable by removing 3.5" of the outer jacket. Bare 1/4" on the ends of the signal wires. See cautionary note below on wire approval, shielding, size, etc.

Loosen the outer nuts on the liquid tight cord grips. Remove rubber plug from the cord grip.

Insert a sufficient length of signal cable through the cord grip to allow for wiring.

Make connections as required (see pin diagram on p67).

Adjust signal cable so that the outer jacket is flush with the inside of the cord grip. Tighten the cord grip nut flush with the cord grip body.

Replace signal cover, ensuring that the signal wires do not get pinched between the signal cover and pump body.

Replace the signal cover screws, using care to find existing threads, and tighten until the signal cover is evenly and fully tightened down flush.

 **WARNING** Failure to properly tighten or secure the cord grip or signal cover may allow water to enter the pump enclosure, which can cause pump failure, property damage, or personal injury.

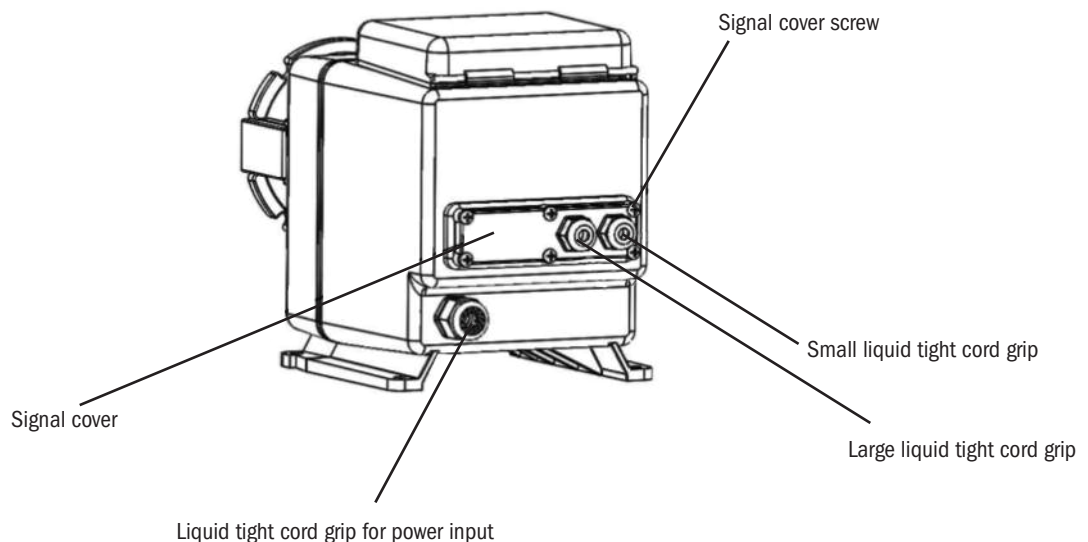

 **CAUTION** Signal cables must be UL, cUL AWM Style 2464 approved with conductors between 28 AWG and 18 AWG. Jacket diameter for small liquid tight must be 0.064" to 0.210". Jacket diameter for large liquid tight must be 0.114" to 0.250".

# CONNECTIONS continued

## REAR OF THE PUMP WITH SIGNAL COVER REMOVED

**⚠ CAUTION** If connecting a shielded signal cable to the pump signal cable, ensure that the shield wire is properly grounded on the controller (non-pump) side.

**⚠ CAUTION** DO NOT run signal wires in proximity to high voltage wires.

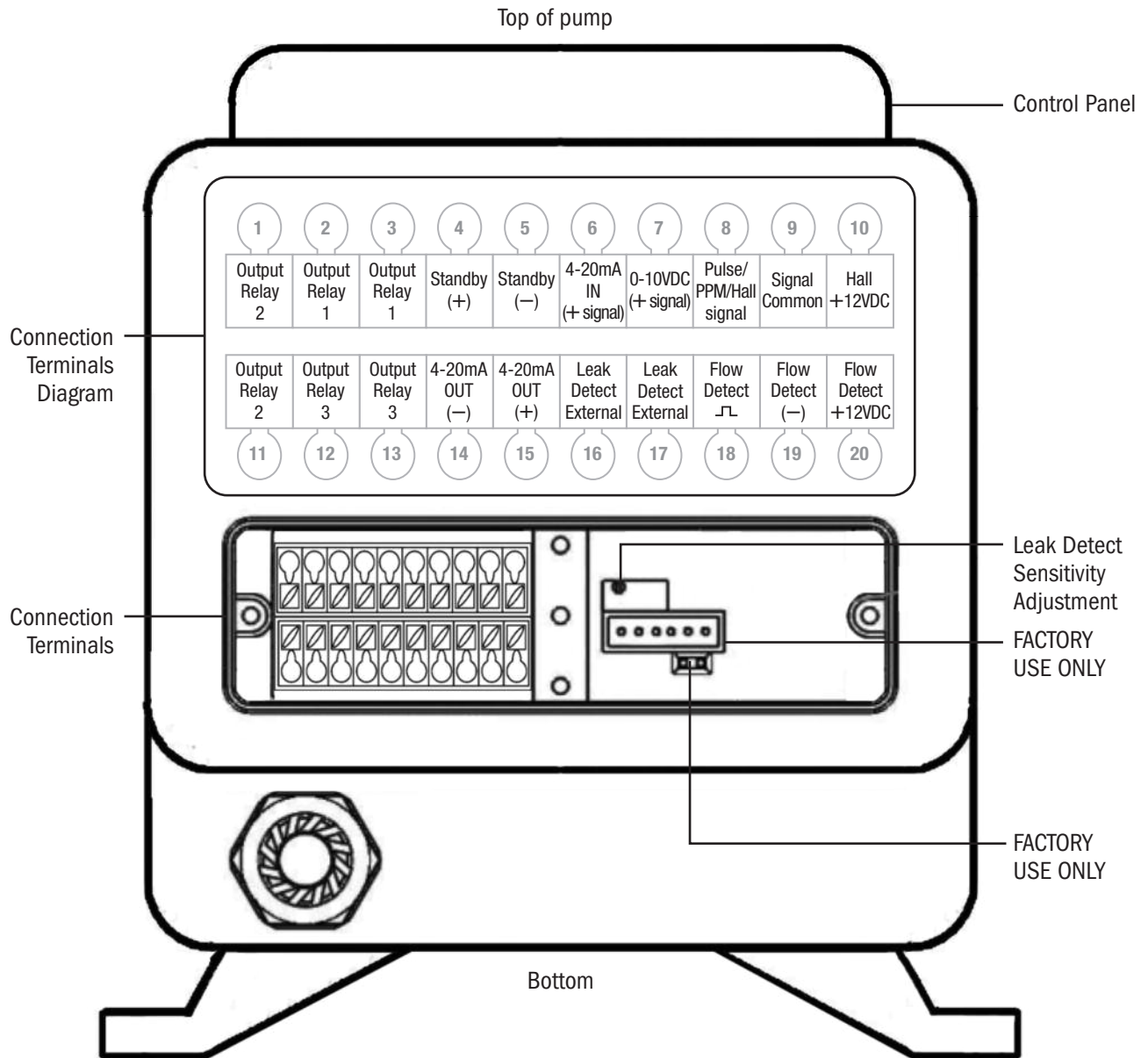

# CONNECTIONS continued

## HALL EFFECT OR PPM VARIABLE FEED

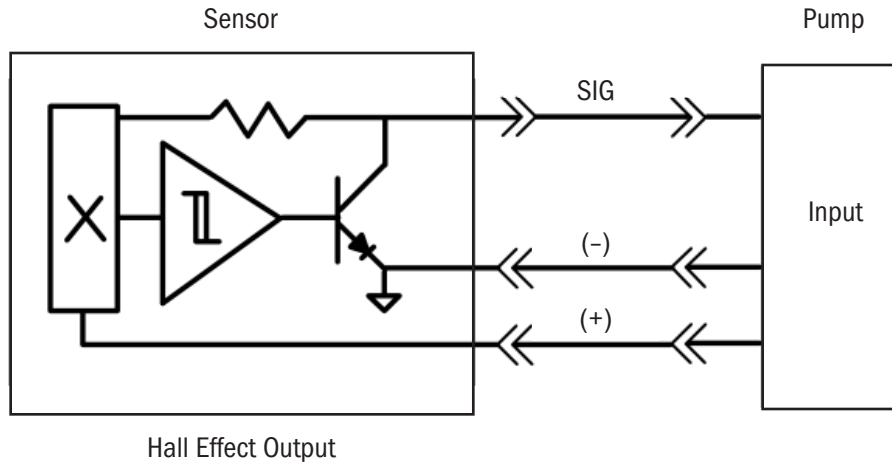

### Connection Terminals

- Connect meter positive input to Hall+12VDC, position #10 on the top row.
- Connect meter common to Signal Common, position #9 on the top row.
- Connect meter signal to Pulse/PPM/Hall signal, position #8 on the top row.

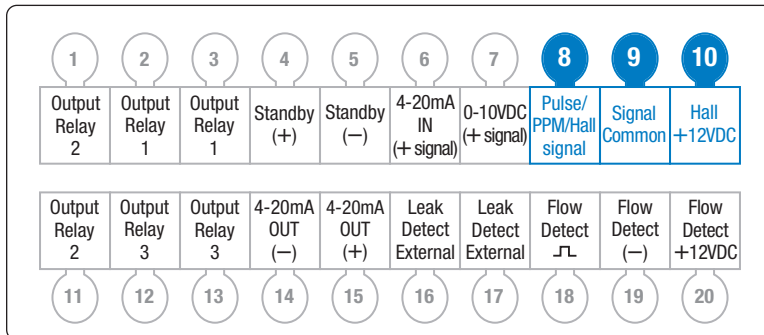

**⚠ CAUTION** The 12VDC supply from connection #10 is limited to 20mA and is only for powering Hall Effect sensors on turbine or paddlewheel type flow meters. Do not use the 12VDC output for anything else; otherwise, damage to the pump will occur.

# CONNECTIONS continued

## PULSE OR PPM CONSTANT FEED

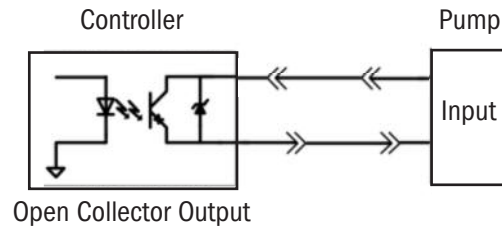
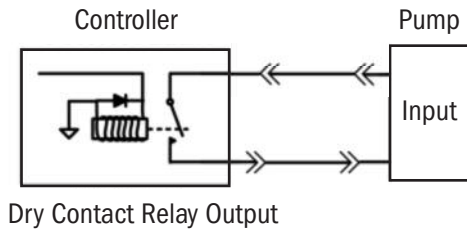

### Connection Terminals

#### For connection to a Dry Contact

- There is no polarity to observe.
- Connect dry contact relay to Pulse/PPM/Hall signal, position #8 and Signal Common, position #9 on the top row.

#### For connection to an Open Collector output

- Polarity must be observed.
- Connect OC positive to Pulse/PPM/Hall signal, position #8 on the top row.
- Connect OC common to Signal Common, position #9 on the top row.

1	2	3	4	5	6	7	8	9	10
Output Relay 2	Output Relay 1	Output Relay 1	Standby (+)	Standby (-)	4-20mA IN (+ signal)	0-10VDC (+ signal)	Pulse/PPM/Hall signal	Signal Common	Hall +12VDC
Output Relay 2	Output Relay 3	Output Relay 3	4-20mA OUT (-)	4-20mA OUT (+)	Leak Detect External	Leak Detect External	Flow Detect $\neg$	Flow Detect (-)	Flow Detect +12VDC
11	12	13	14	15	16	17	18	19	20

# CONNECTIONS continued

## 4-20mA INPUT

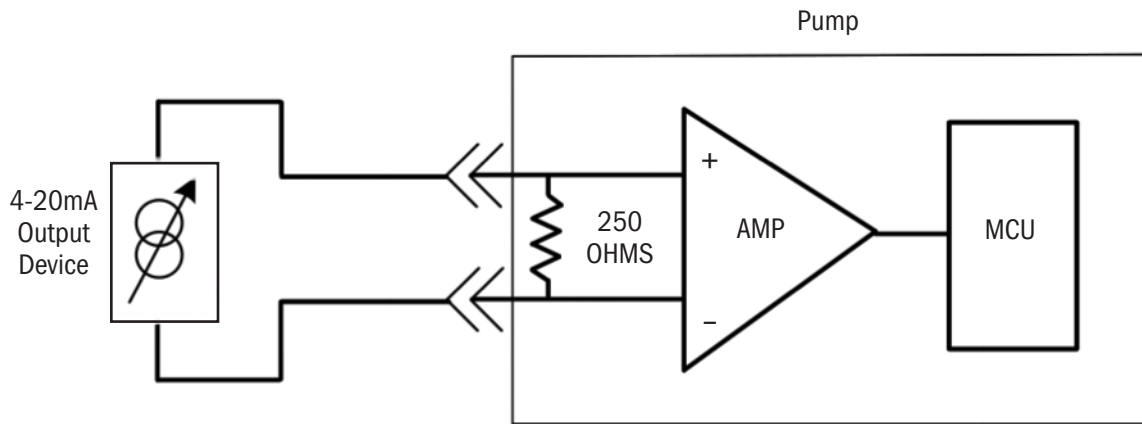

Pump signal impedance is 250 ohms.

**⚠ CAUTION** Maximum voltage on the signal line is 36VDC.

### Connection Terminals

- Connect signal positive input to 4-20mA IN (+ signal), position #6 on the top row.
- Connect signal common to Signal Common, position #9 on the top row.

1	2	3	4	5	6	7	8	9	10
Output Relay 2	Output Relay 1	Output Relay 1	Standby (+)	Standby (-)	4-20mA IN (+ signal)	0-10VDC (+ signal)	Pulse/PPM/Hall signal	Signal Common	Hall +12VDC
Output Relay 2	Output Relay 3	Output Relay 3	4-20mA OUT (-)	4-20mA OUT (+)	Leak Detect External	Leak Detect External	Flow Detect $\square$	Flow Detect (-)	Flow Detect +12VDC
11	12	13	14	15	16	17	18	19	20

# CONNECTIONS continued

## STANDBY

The STANDBY function allows for the pump to be stopped remotely. If a dry contact or open collector signal is received to the STANDBY inputs, the pump will cease operation as long as the signal is present. The pump will also flash “STANDBY” on the operating display.

NOTE: The STANDBY function can be used to transfer operation to a secondary pump in the event of a primary pump failure. An output relay on the primary pump is programmed for TRANSER and Normally Closed. This relay provides an input to the STANDBY function of the secondary pump, which is programmed identically to the primary pump. In the event of a loss of power or an alarm event that shuts down the primary pump, the output relay on the primary pump opens and activates the secondary pump.

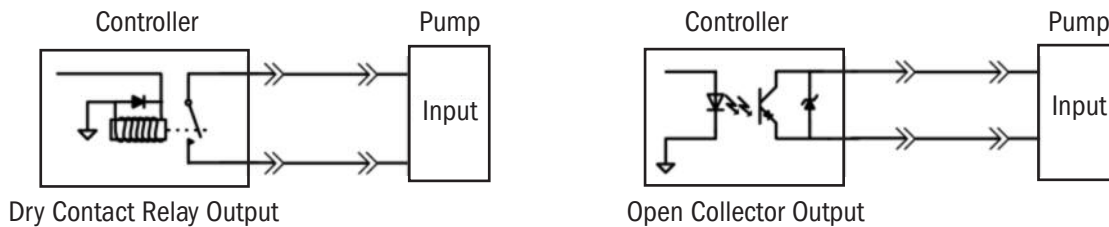

### Connection Terminals

#### For connection to a Dry Contact

- There is no polarity to observe.
- Connect relay to Standby (+), position #4 and Standby (-), position #5 on the top row.

#### For connection to an Open Collector output

- Polarity must be observed.
- Connect OC positive to Standby (+), position #4 on the top row.
- Connect OC common to Standby (-), position #5 on the top row.

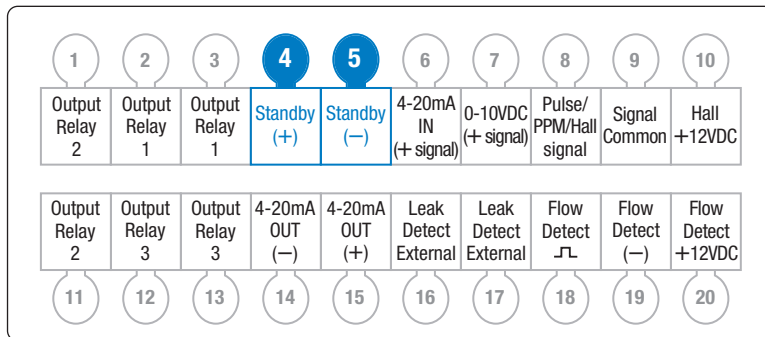

# CONNECTIONS continued

## 0-10VDC

### Connection Terminals

- Connect signal positive input to 0-10VDC (+ signal), position #7 on the top row.
- Connect signal common to Signal Common, position #9 on the top row.

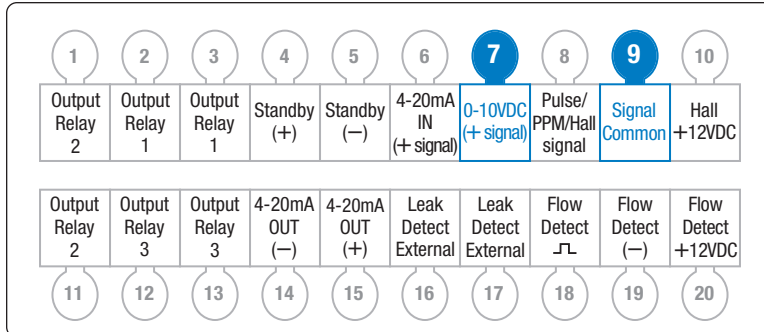

# CONNECTIONS continued

## OUTPUT RELAYS

### Connection Terminals

The relays are dry contacts, so there is no polarity to observe.

NOTE: The output relays are Normally Open.

**⚠ CAUTION** The output relays are for signal level only. Max rating is for 24VDC at 50mA.

### Output Relay #1

Connect to Output Relay 1 in positions #2 & #3 on the top row.

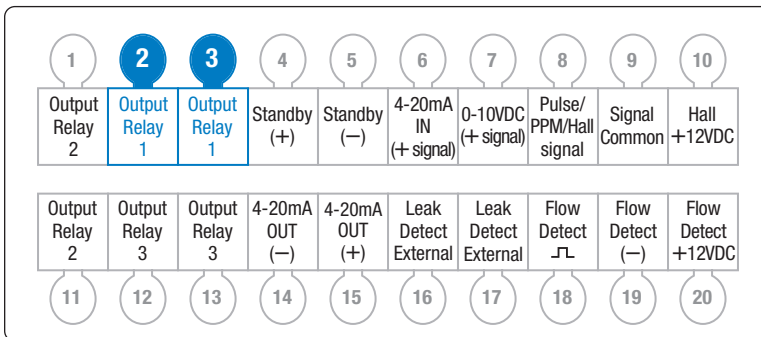

### Output Relay #2

Connect to Output Relay 2 in positions #1 on the top row and #11 on the bottom row.

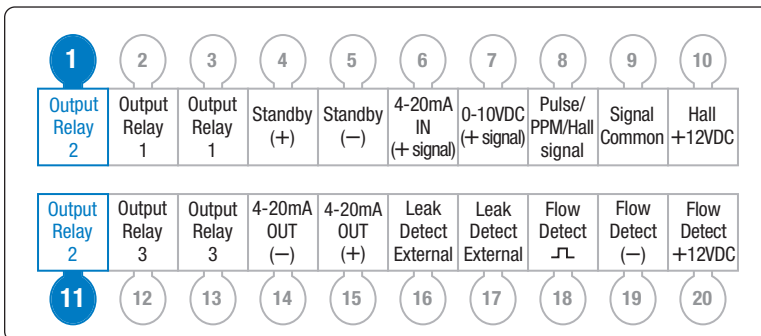

### Output Relay #3

Connect to Output Relay 3 in positions #12 and #13 on the bottom row.

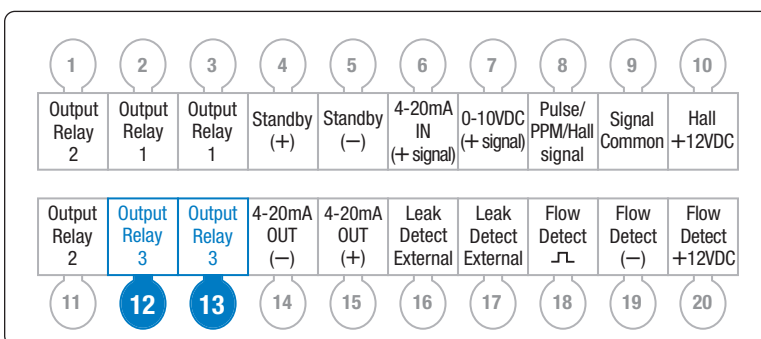



# CONNECTIONS continued

## 4-20mA OUTPUT page 1 of 2

The pump is equipped with a 4-20 mA output signal.

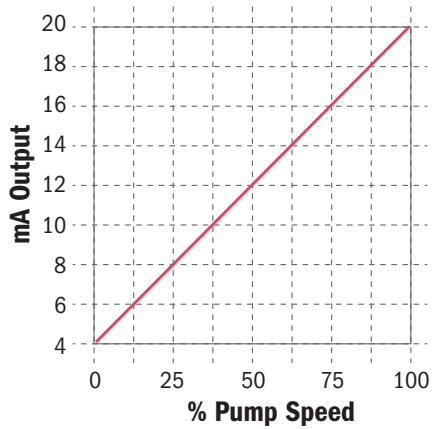

This signal corresponds proportionally to pump speed with 0% pump speed equaling 4.0mA and 100% pump speed equaling 20.0mA. The signal response is not adjustable by the user.

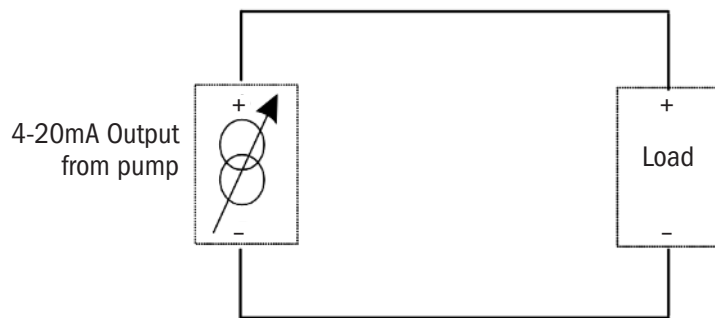

The pump sources the voltage for the output signal loop at 24VDC. The pump will control the magnitude of current on the loop (from 4 to 20mA) according to the speed that the pump is running at. The maximum loop impedance (load on the output signal loop) is 300 ohms, which includes the load plus any resistance due wire length, connections, etc.

- ⚠ **CAUTION** The loop impedance must be less than 300 ohms.
- ⚠ **CAUTION** Do not short the 4-20mA output loop. Doing so will cause the pump to shut off and may damage the pump.
- ⚠ **CAUTION** To ensure proper signal output, always calibrate the output signal.

### Connection Terminals

- Connect load positive to 4-20mA OUT (+), position #15 on the bottom row.
- Connect load common to 4-20mA OUT (-), position #14 on the bottom row.

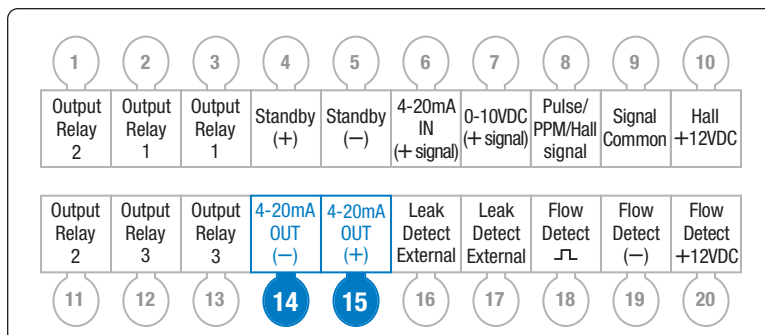

# CONNECTIONS continued

## 4-20mA OUTPUT page 2 of 2

### CALIBRATING 4-20mA OUTPUT

The 4-20mA output will produce a signal that corresponds to the speed percentage that the pump is running (4mA=0% pump speed & 20mA=100% pump speed).

To calibrate the output loop - navigate to the signal calibration selection in the configuration menu - with the pump installed - place a process or a multimeter in the loop.

NOTE: When entering this menu the output is activated only when the value is changed by pressing the up or down arrows.

Adjust the value in the "4mA out set" menu to indicate 4mA in the process loop and press enter. this is the zero adjustment parameter.

Next adjust the value in the "20mA out set" menu to indicate 20mA in the process loop and press enter. this is the span adjustment parameter.

Go to manual mode. set the pump speed at 100%. note the difference between the current loop value and 20mA - return to the output signal calibration menu and readjust (add or subtract) the output level by the difference noted.

Verify the process loop by setting the pumps speed to 25%, 50%, & 75%. the loop current should be 8mA, 12mA, & 16mA respectively.

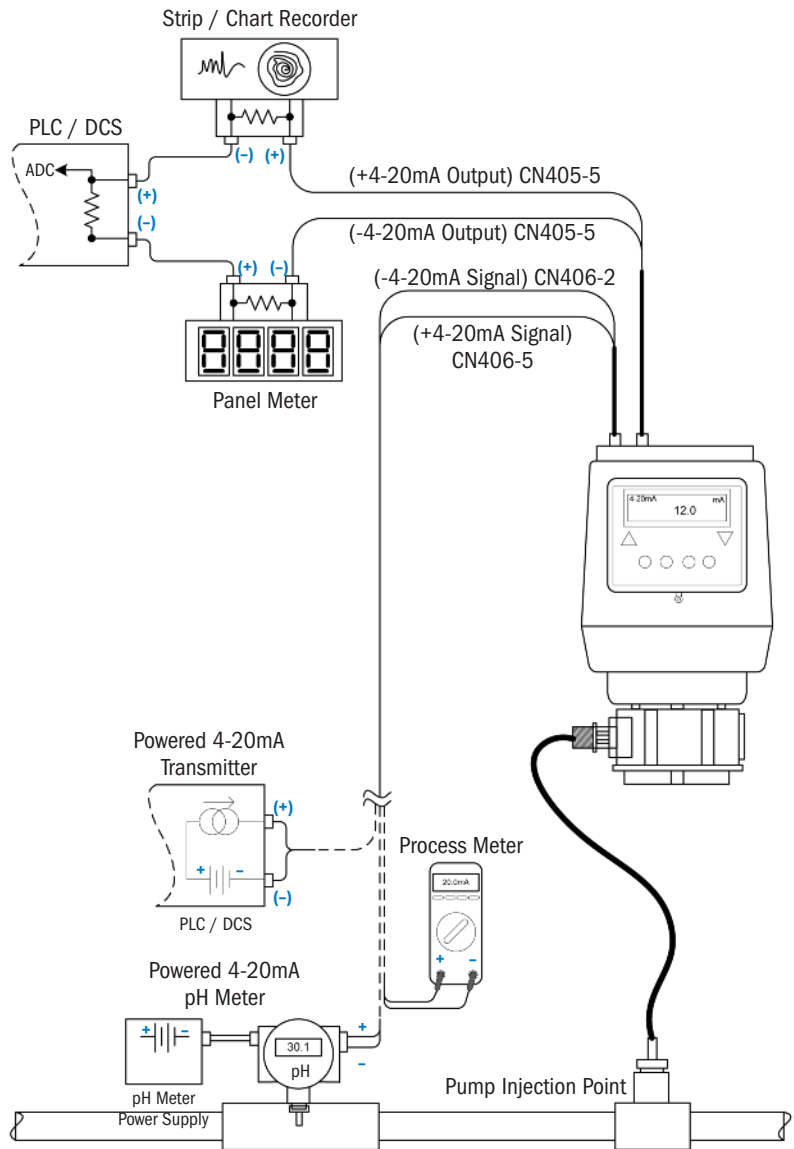

# CONNECTIONS continued

## LEAK DETECT page 1 of 3

The S Series pump includes a highly sensitive leak detector. The detector can differentiate between a tube rupture leak and water intrusion. The sensitivity feature reduces the number of false “tube leak” signals due to the pump’s location in a wet environment, outdoors or if subject to hose down cleaning.

**⚠️WARNING** TO BE INSTALLED AND MAINTAINED BY PROPERLY TRAINED PROFESSIONAL INSTALLER ONLY. READ MANUAL & LABELS FOR ALL SAFETY INFORMATION & INSTRUCTIONS.

**⚠️CAUTION** Turn off water system, disable all pumps and depressurize the system before performing installation. Always wear proper protective safety equipment when working with metering pumps.

- Field calibration of the pump in the application assures the “tube leak” signal represents the application’s chemical and concentration.
- Refer to Configuration Menu section in the pump manual (pages 21-22) to select, fine-tune and program the responses available when a “tube leak” signal is received.
- The leak detect sensitivity is factory pre-set to distinguish between water and typical water treatment chemicals. Adjust the sensitivity according to the specific chemical utilized in the application. Adjust with the potentiometer located under the signal cover, see below.
- When using external leak detect probes (not included with pump), connect to Leak Detect External, positions #16 and #17 on the bottom row of the terminal on rear of the pump. The probes can monitor leakage in areas other than the pump head. The probes should be constructed of Hastelloy® to inhibit corrosion.

NOTE: The leak detect function has one sensitivity adjustment. When external probes are used, confirm the sensitivity setting is acceptable for the probes and liquid end.

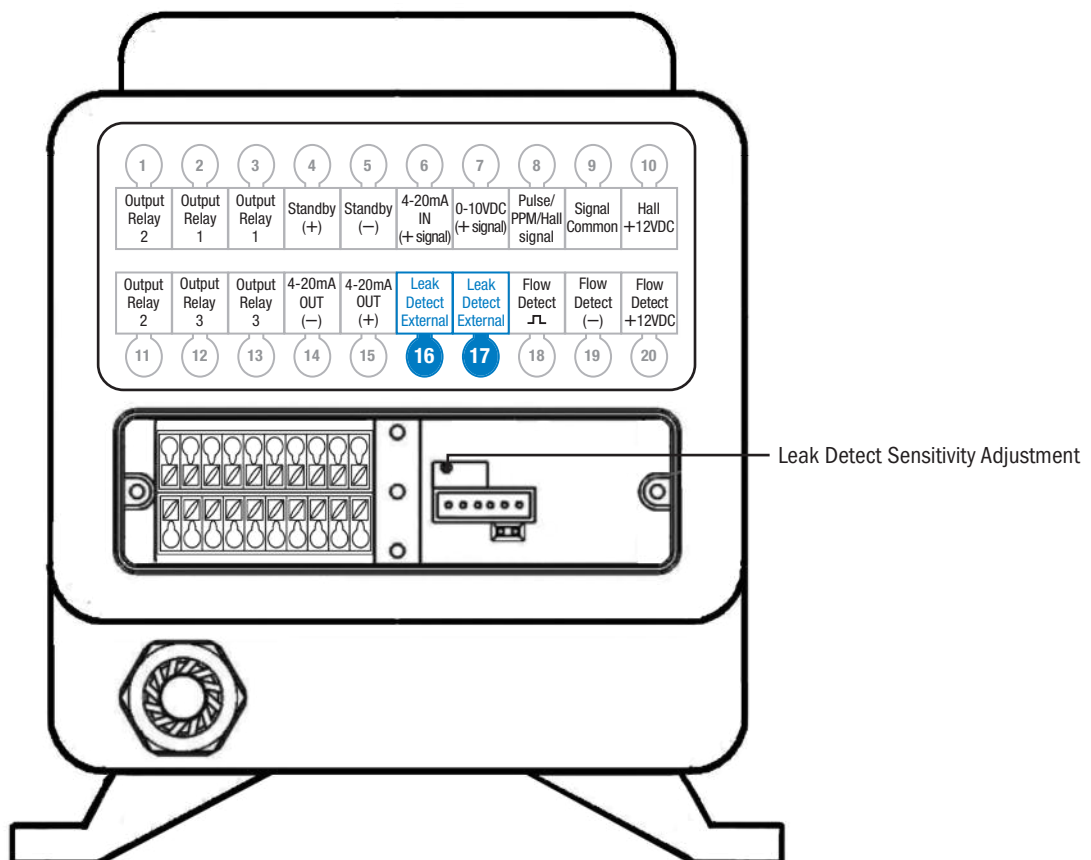

# CONNECTIONS continued

## LEAK DETECT page 2 of 3

### ADJUSTING THE LEAK DETECT SETTING

#### Check The Leak Detect Setting

1. In the Configuration Menu, verify that “Alarm on Tube leak” is set to NO.
2. Set the pump to MANUAL mode at 0%.
3. Unplug the pump.
4. Remove tube housing cover.
5. Remove the signal cover to allow access to the leak detect adjustment potentiometer, *Illustration A*.
6. Plug the pump in.
7. Soak a small piece of sponge with the pumping solution and place over the two leak detect pins, *Illustration B*. In this step, use the expected weakest solution and keep in mind some solutions dilute with time.
8. Observe whether the tube leak icon is shown on the display, *Illustration C*.
  - If yes, slowly turn the leak detect adjustment clockwise, *Illustration A* until the tube leak icon is not displayed, then proceed to step 9.
  - If the pump does not display the tube leak icon, proceed to step 9.

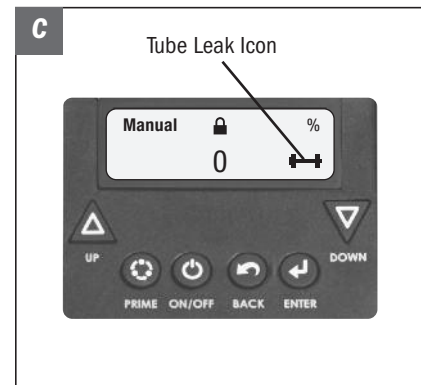
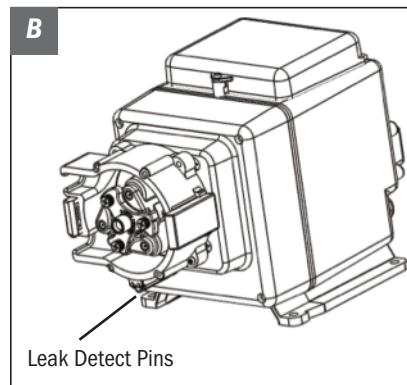
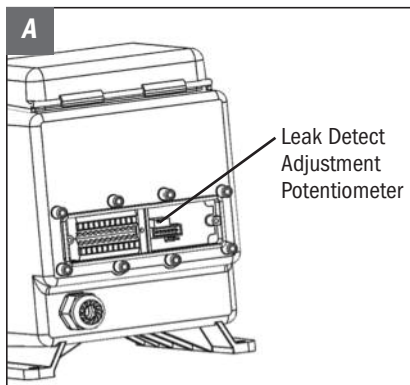

# CONNECTIONS continued

## LEAK DETECT page 3 of 3

### ADJUSTING THE LEAK DETECT SETTING

#### Check The Leak Detect Setting continued

9. Slowly turn the potentiometer counterclockwise until the tube leak icon is visible and not flickering, *Illustration C*. Turn slightly past this point to assure a solid tube leak icon is shown.
10. Thoroughly clean the solution off the pins and confirm they are dry, *Illustration B*. Confirm the tube leak icon is not displayed. **IMPORTANT:** Confirm there is no chemical residue remaining on the leak detect pins and bracket, *Illustration B*.
11. If the pump is not outdoors or exposed to water, go to Reassembly.
12. If the pump will be installed outdoors or exposed to water:
  - Soak a small piece of sponge in water and place over the two leak detect pins, *Illustration B*. If the tube leak icon displays, *Illustration C*, it indicates the conductivity of the pumped solution and water is too close and the pump cannot discriminate between the two. The liquid end needs to be protected from water intrusion to avoid a false tube leak signal.
  - If the tube leak icon does not show, the setting is complete. Go to Reassembly.

#### Reassembly

13. Re-install the tube housing cover and refer to page 65 to re-install the signal cover.
14. Refer to:
  - Page 84, #5-7 to prime the pump.
  - Page 23 to enable the leak detect.
  - Pages 29-52 to set the mode of operation.
15. Verify pump operation.

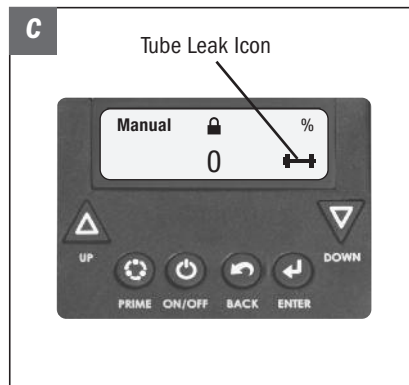
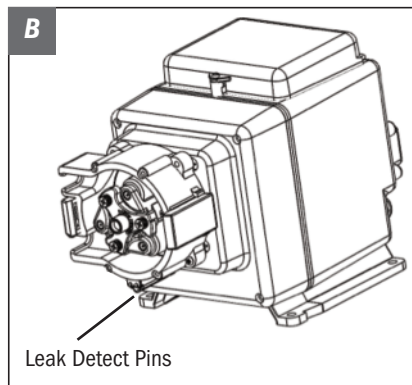

# INSTALLATION

## ADDITIONAL SAFETY INSTRUCTIONS

**!** **NOTICE:** Indicates special instructions or general mandatory action.

- !** Read all safety hazards before installing or servicing the pump. The pump is designed for installation and service by properly trained personnel.
- !** Use all required personal protective equipment when working on or near a chemical metering pump.
- !** Install the pump so that it is in compliance with all national and local plumbing and electrical codes.
- !** Use the proper product to treat potable water systems, use only chemicals listed or approved for use.
- !** Inspect tube frequently for leakage, deterioration, or wear. Schedule a regular pump tube maintenance change to prevent chemical damage to pump and/or spillage.
- !** Recommended mounting is vertical with pump head pointed downward.

# INSTALLATION continued

## MOUNT PUMP

- ❗ Recommended mounting is vertical with pump head pointed downward.
  - ❗ Select a dry location (to avoid water intrusion and pump damage) above the solution tank. Best recommended location is above the solution tank in a vertical position with the pump head pointed downward.
  - ❗ To prevent pump damage in the event of a pump tube leak, never mount the pump vertically with the pump head up.
  - ❗ To avoid chemical damage from fumes, DO NOT mount pump directly over an open solution tank. Keep tank covered.
  - ❗ Avoid flooded suction or pump mounted lower than the solution container. Draw solution from the top of the tank. Pump can run dry without damage. If pump is installed with a flooded suction, a shut-off valve or other device must be provided to stop flow to pump during service.
1. Use the mounting bracket as a template to drill pilot holes in mounting location.
  2. Secure bracket with fasteners or wall anchors. Slide pump into bracket.
- ❗ Provide 8" clearance to allow pump removal.
  - ❗ To prevent damage, verify with a volt meter that the receptacle voltage corresponds with the pump voltage.

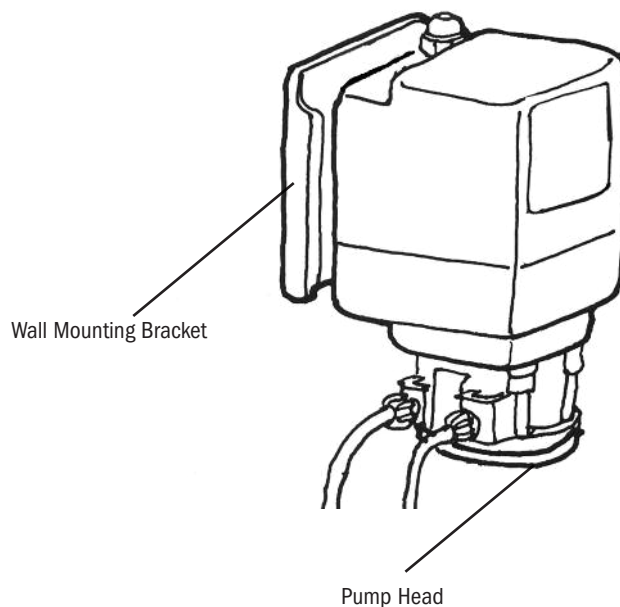

# INSTALLATION continued

## DIAGRAM

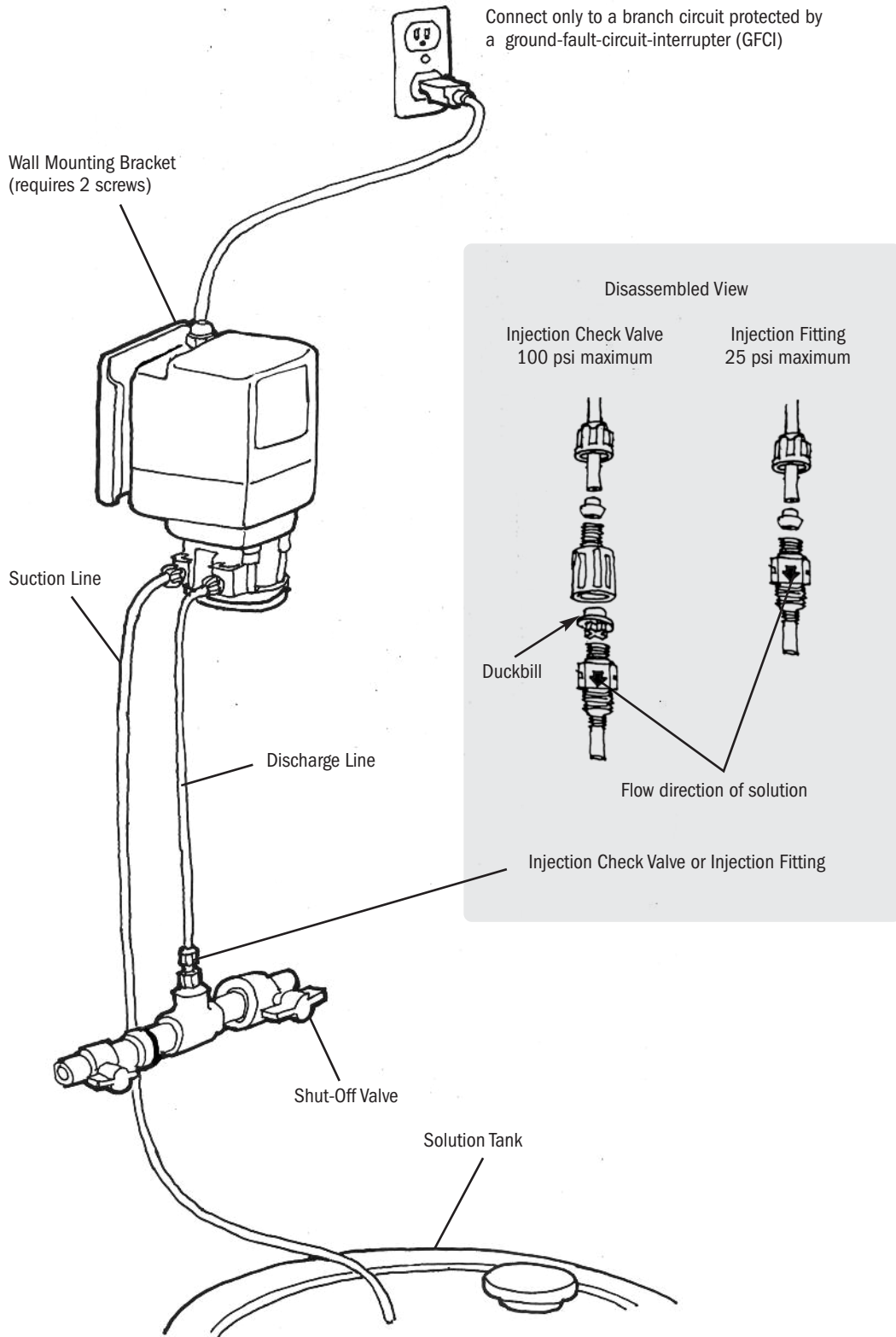



# INSTALLATION continued

## INSTALL SUCTION LINE TO PUMP HEAD

1. Uncoil the suction/discharge line. Use outside of solution tank as a guide to cut proper length of suction line ensuring it will be 2-3" above the bottom of solution tank.
- ❗ **Allow sufficient slack to avoid kinks and stress cracks. Always make a clean square cut to assure that the suction line is burr free. Normal maintenance requires trimming.**
  - ❗ **Suction lines that extend to the bottom of the tank can result in debris pickup leading to clogged injectors and possible tube failure.**
2. Make connections by sliding the line(s) through connecting nut and ferrule and finger tighten to the corresponding tube fittings.
  3. Finger tighten nut to the threaded tube fitting while holding the tube fitting.
- ❗ **Over tightening the ferrule and nut with a wrench may result in damaged fittings, crushed ferrules, and air pick up.**
  - ❗ **DO NOT use thread seal tape on pump tube connections or tools to tighten connections.**

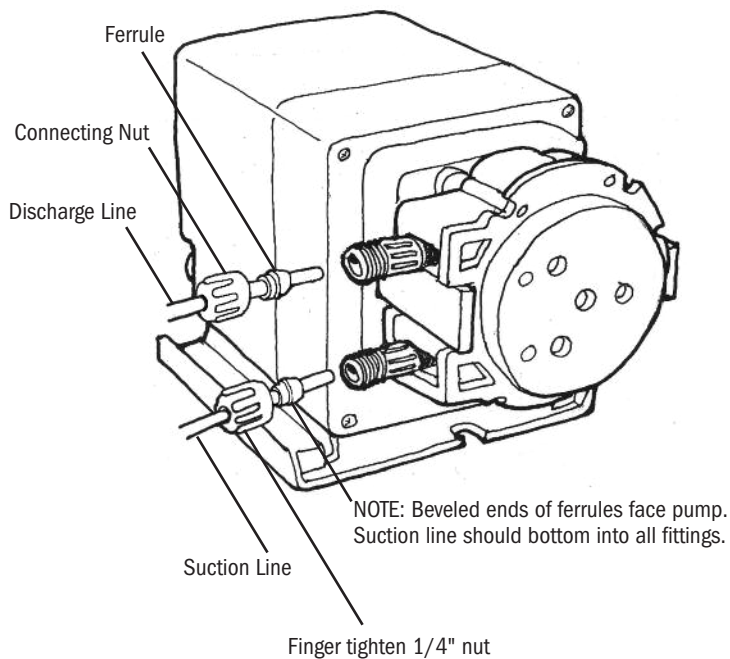

DO NOT use thread seal tape on pump tube threads.  
DO NOT use pliers.

# INSTALLATION continued

## INSTALL SUCTION WEIGHT TO SUCTION LINE

1. Drill a hole into the bung cap or solution tank lid. Slide the tubing through and secure the weighted strainer to the line.
  2. To attach the strainer, push approximately 3.5" of suction line through the cap on the strainer body. Pull tubing to make sure it is secure.
  3. Suspend slightly above tank bottom to reduce the chance of sediment pickup.
- !** DO NOT mix chemicals in the solution container. Follow recommended mixing procedures according to the manufacturer.
- !** DO NOT operate pump unless chemical is completely in solution. Turn pump off when replenishing solution.

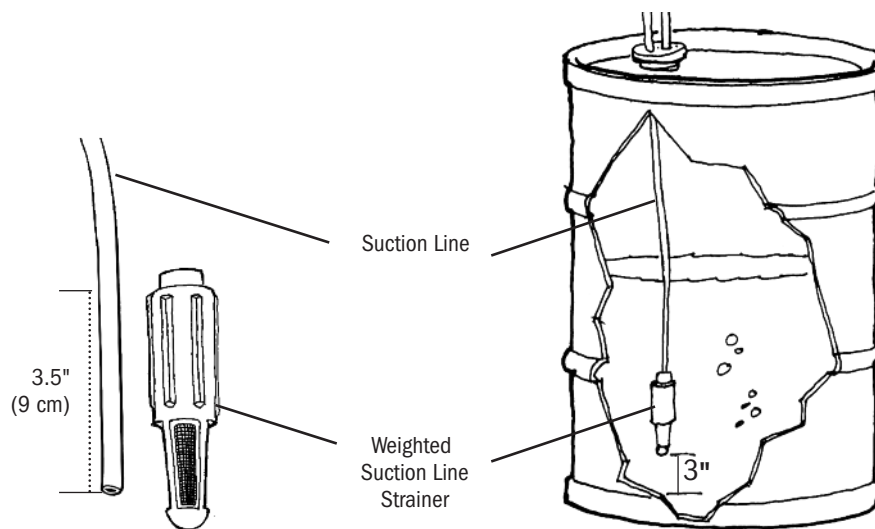

# INSTALLATION continued

## INSTALL DISCHARGE LINE TO PUMP HEAD AND INJECTION POINT

1. Make a secure finger tight connection on the discharge fitting of the pump head as instructed in Install Suction Line instructions.

**!** DO NOT use thread seal tape on pump tube connections or tools to tighten connections.

**⚠** **WARNING** HAZARDOUS PRESSURE: Shut off water or circulation system and bleed off any system pressure.

**!** Locate a point of injection beyond all pumps and filters or as determined by the application.

2. A 1/4" or 1/2" Female NPT (FNPT) connection is required for installing the injection fitting. If there is no FNPT fitting available, provide one by either tapping the pipe or installing FNPT pipe tee fitting.
3. Wrap the Male NPT (MNPT) end of injection fitting with 2 or 3 turns of thread seal tape. If necessary, trim the injection fitting quill as required to inject product directly into flow of water.

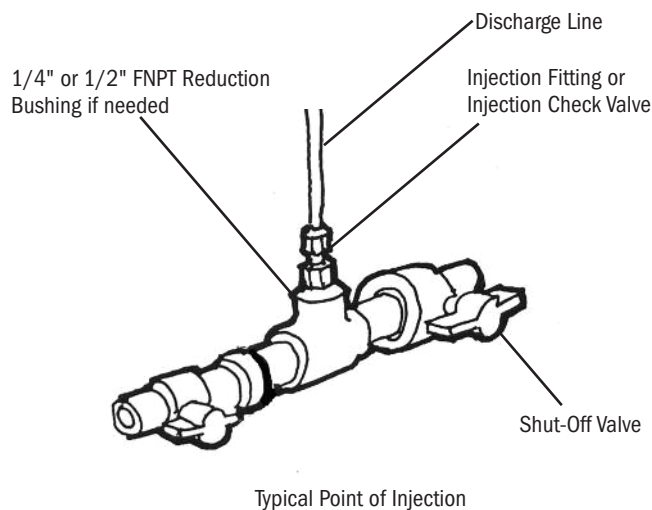

DO NOT use thread seal tape on pump tube threads.  
DO NOT use pliers.

# INSTALLATION continued

4. Hand tighten the injection fitting into the FNPT fitting.

## 0-25 psi Model (includes injection fitting)

- a. Install connecting nut and ferrule to the pump discharge line. Insert discharge line into injection fitting until it reaches base of fitting.
- b. Finger tighten connecting nut to fitting.

## 26-100 psi Model (includes injection check valve)

- a. Prior to connection, test injection check valve and NPT threads for leaks by pressurizing system. If necessary, tighten an additional 1/4 turn.
- b. Install connecting nut and ferrule to the pump discharge line. Insert discharge line into check valve body until it reaches base of body.
- c. Finger tighten connecting nut to fitting.

5. Depress and hold the prime button and allow pump to fully prime. The prime button will run the pump and when released the pump will return to automatic mode.
6. Re-pressurize system, observe chemical flow as actuated by system and check all connections for leaks.
7. After suitable amount of dosing time, perform tests for desired chemical readings. If necessary, fine tune dosing levels by adjusting solution strength.

 **The injection point and fitting require periodic maintenance to clean any deposits or buildup. To allow quick access to the point of injection, Stenner recommends the installation of shut-off valves.**

# TROUBLESHOOTING – MOTOR

 **WARNING** HAZARDOUS VOLTAGE: DISCONNECT power cord before removing motor cover for service.  
Electrical service should be performed by trained personnel only.

PROBLEM	POSSIBLE CAUSE	SOLUTION
Display is blank or not readable	No power cord connection point Failed power supply Pump requires re-initialization Display is too dim	Check voltage of receptacle/controller output voltage Return to factory for evaluation Cycle power to the pump Increase display brightness in the CONFIGURATION menu
No response to input signal	Pump is in alarm or STANDBY condition Pump is not in the correct mode No signal or improper signal level input to the pump Input signal is not wired correctly	Clear and correct any alarm or indicated conditions (leak detect, standby, etc.) Ensure that pump has been programmed for the correct input signal and that the operating display shows the desired mode of operation If in signal mode, confirm signal level input to the pump by looking for the icon on the screen Confirm that the input signal is connected to the correct wires
Output is erratic	Signal is fluctuating rapidly Noise on the signal wire	Check stability of signal being input to the pump If shielded wire is connected to the pump input signal cable, ensure it is properly grounded at the signal source
Output is higher or lower than expected	Signal is fluctuating rapidly Pump calibration data is incorrect Input signal level is higher or lower than anticipated	Check programming, ensure the values entered are correct Check that the value entered for CALIBRATION in the CONFIGURATION menu is correct Check input signal level to the pump
Pump cycles ON/OFF	Failed fan Pump is too hot Red (+12VDC) wire on the signal cable is not capped and insulated (if not terminated) Load too high or shortened on 4-20mA output	Return to factory for evaluation Check that maximum ambient temperature is less than 104°F; Shade pump if exposed to direct sunlight Cap and insulate the Red wire to prevent it from shorting Maximum loop impedance is 300mA; Ensure output is not shortened

# TROUBLESHOOTING – MOTOR continued

PROBLEM	POSSIBLE CAUSE	SOLUTION
Display is working, pump is not	<p>Pump requires re-initialization</p> <p>Failed motor</p> <p>Pump is in alarm or STANDBY</p> <p>Pump is not in the correct mode</p> <p>No signal or improper signal level input to the pump</p> <p>Input signal is not wired correctly</p>	<p>Cycle power to the pump</p> <p>Return to factory for evaluation</p> <p>Clear and correct any alarm or indicated conditions (leak detect, standby, etc.)</p> <p>Ensure that pump has been programmed for the correct input signal and that the operating display shows the desired mode of operation</p> <p>If in signal mode, confirm signal level being input to the pump is correct</p> <p>Confirm that the input signal is connected to the correct wires</p>
Pump does not alarm for given condition	<p>Incorrect programming or alarm condition not set up</p> <p>Relay is incorrectly configured</p> <p>Relay output wired incorrectly</p>	<p>Ensure that alarm is enabled for the programmed mode</p> <p>Ensure relay is properly configured for NO or NC in the program</p> <p>Output relays are dry contact and do not provide any voltage; Confirm that wiring is correct</p>
Operating display shows incorrect units	<p>Incorrect programming</p> <p>Display unit has been cycled</p>	<p>Check that the value entered for UNITS in the CONFIGURATION menu is correct</p> <p>Press the BACK button to cycle through available display options</p>
Can't enter Main Menu	Forgot password	Contact the factory for password reset
Leak detect not working	<p>Incorrect programming</p> <p>Check that leak detect bracket is installed, clips are in place, and leak pins are making contact with pins on case</p> <p>Leak detect sensitivity was improperly adjusted or does not match application</p>	<p>Ensure that alarm is enabled for the programmed mode</p> <p>Install leak detect option; check to ensure that pins are clean and making good contact</p> <p>Adjust the leak detect sensitivity so that the unit detects the chemical; Ensure that the setting is such that the unit does not activate with water if not located in a dry location</p>

# TROUBLESHOOTING – PUMP HEAD

PROBLEM	POSSIBLE CAUSE	SOLUTION
Components cracking	Chemical attack	Check chemical compatibility
Pump head leaking	Pump tube rupture	Replace pump tube, ferrules; center tube
No pump output, pump head rotates	Depleted solution tank Pump suction line weight is above solution Leak in the suction line Ferrules installed incorrectly, missing or damaged Injection point is clogged Clogged suction and/or discharge line and/or injection check valve Life of pump tube exhausted Suction line is flush with the nose of the weighted strainer	Replenish solution Maintain suction line 2-3" above bottom of tank Inspect or replace suction line Replace ferrules  Inspect and clean injection point Clean and/or replace as needed  Replace pump tube, ferrules; center tube Pull suction line approximately 1" from bottom of strainer, cut bottom of suction line at an angle
Low pump output, pump head rotates	Life of pump tube exhausted Rollers worn or broken Injection point is restricted Incorrect tube size High system back pressure	Replace pump tube, ferrules; center tube Replace roller assembly Inspect and clean injection point Replace tube with correct size Verify system pressure against tube psi, replace tube if needed
No pump output, pump head doesn't rotate	Stripped roller assembly Motor problem	Replace roller assembly Refer to motor section
Pump output high	Incorrect tube size or setting  Roller assembly broken	Replace tube with correct size or adjust settings  Replace roller assembly

# TROUBLESHOOTING – PUMP TUBE







**NOTICE:** A leaking pump tube damages the metering pump. Inspect pump frequently for leakage and wear. Refer to Tube Replacement section for additional safety precautions and instructions.

PROBLEM	POSSIBLE CAUSE	SOLUTION
Tube leaking	Pump tube ruptured Calcium or mineral deposits  Excessive back pressure  Tube is twisted Tube not centered	Replace pump tube, ferrules; center tube Clean injection fitting, replace pump tube, ferrules; center tube  Verify system pressure against tube psi, replace tube if needed  Replace pump tube, ferrules; center tube Replace pump tube, ferrules; center tube
Tube life is shortened	Chemical attack Mineral deposits at injection point  Sediment blockage at check valve  Degraded check valve duckbill Duckbill in wrong orientation Tube manually stretched or pinched during replacement  Seized rollers caused abrasion on tube Exposure to heat or sun	Check chemical compatibility Remove deposits, replace pump tube, ferrules; center tube  Clean injection fitting, ensure suction line is 2-3" above bottom of tank  Replace duckbill at every tube change Reverse duckbill orientation  Follow tube replacement instructions and allow roller assembly to stretch tube into place  Clean roller assembly or replace Do not store tubes in high temperatures or in direct sunlight
Tube connection is leaking	Missing ferrule on 1/4" line Crushed ferrule Ferrule in wrong orientation	Replace ferrule Replace ferrule Reverse orientation of ferrule



# TUBE REPLACEMENT – SAFETY INFORMATION



## **WARNING** RISK OF CHEMICAL EXPOSURE

-  To reduce risk of exposure, check the pump tube regularly for leakage. At the first sign of leakage, replace the pump tube.
-  To reduce risk of exposure, the use of proper personal protective equipment is mandatory when working on or near chemical metering pumps.
-  To reduce risk of exposure, and also prior to service, shipping, or storage, pump generous amounts of water or a compatible buffer solution to remove chemical from pump.
-  Consult chemical manufacturer and MSDS sheet for additional information and precautions for the chemical in use.
-  Personnel should be skilled and trained in the proper safety and handling of the chemicals in use.
-  Inspect tube frequently for leakage, deterioration, or wear. Schedule a regular pump tube maintenance change to prevent chemical damage to pump and/or spillage.





## **CAUTION** PINCH POINT HAZARD

-  Use extreme caution when replacing pump tube. Be careful of your fingers and do not place fingers near rollers.

## **WARNING** HAZARDOUS PRESSURE/CHEMICAL EXPOSURE

-  Use caution and bleed off all resident system pressure prior to attempting service or installation.
-  Use caution when disconnecting discharge line from pump. Discharge may be under pressure. Discharge line may contain chemical.

## **NOTICE: Indicates special instructions or general mandatory action.**

-  **DO NOT** apply grease, oil, or lubricants to the pump tube or housing.
-  Prior to pump tube replacement, inspect the entire pump head for cracks or damaged components. Ensure rollers turn freely.
-  Rinse off chemical residual and clean all chemical and debris from pump head components prior to tube replacement. Apply AquaShield™ to main shaft and tube housing cover bushing during tube replacement.
-  **DO NOT** pull excessively on pump tube. Avoid kinks or damage during tube installation.
-  Inspect the suction and discharge lines, injection point (into pipe), and injection check valve duckbill for blockages after any tube rupture. Clear or replace as required.

# TUBE REPLACEMENT continued

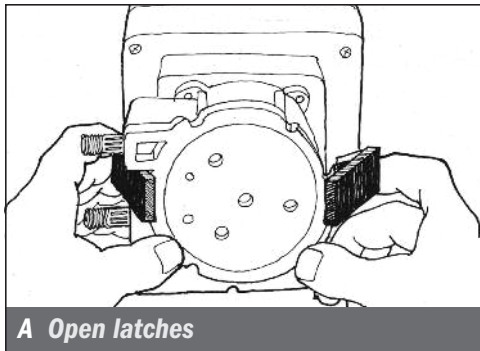

**A** Open latches

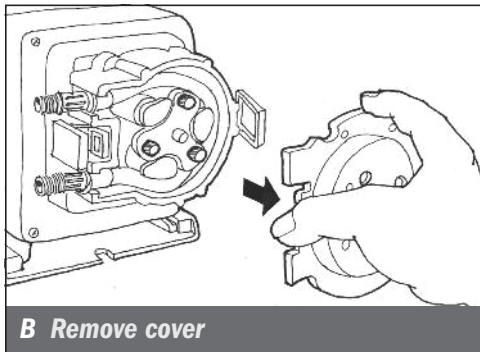

**B** Remove cover

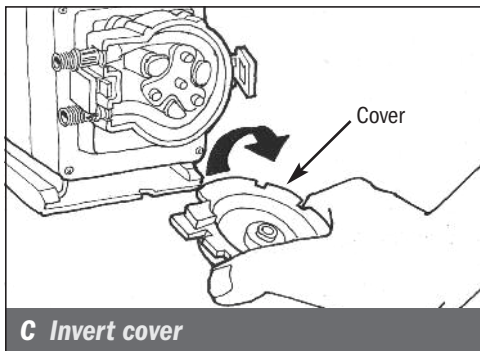

**C** Invert cover

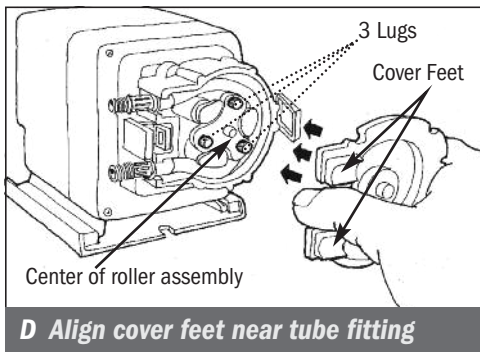

**D** Align cover feet near tube fitting

## PREPARATION

1. Follow all safety precautions prior to tube replacement.
2. Prior to service, pump water or a compatible buffer solution through the pump and suction and discharge lines to remove chemical and avoid contact.

## REMOVE THE PUMP TUBE

1. Unplug the power cord to ensure the power to the pump is off. Disconnect the input signal.
2. Depressurize and disconnect the suction and discharge lines.
3. Open the back and front of the latches on both sides of the head. *Illustration A*  
*For CE pump only: Remove the safety screw on cover.*
4. Remove the tube housing cover and flip to use as a tool in the next step. *Illustration B & C*
5. Align the center of the inverted cover with the center of the roller assembly so that the three holes on the face of the cover align with the three knurled lugs on the roller assembly. Position the cover feet near the tube fittings. *Illustration D*  
NOTE: The roller assembly needs to be collapsed to remove the tube.

# TUBE REPLACEMENT continued

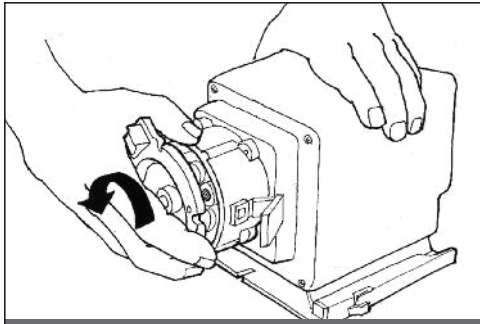

**E** Collapse roller assembly

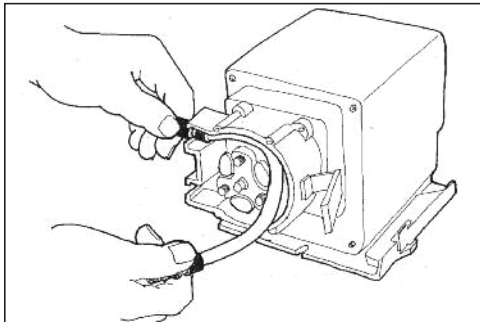

**F** Remove tube

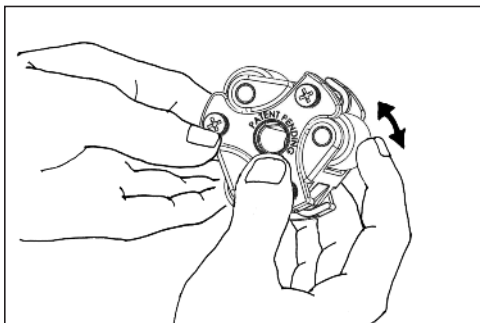

**G** Check rollers

## REMOVE THE PUMP TUBE continued

- 6.** Hold the pump securely, use the tube housing cover as a wrench and quickly (snap) rotate the cover counter-clockwise to collapse the roller assembly. The tube will no longer be pressed against the tube housing wall. *Illustration E*  
NOTE: Counter-clockwise is viewed from facing the head of the pump.
- 7.** Remove and discard the pump tube. *Illustration F*
- 8.** Remove the roller assembly and housing. Set them aside to re-install later.
- 9.** Use a non-citrus all-purpose cleaner to clean chemical residue from the tube housing, roller assembly and cover.
- 10.** Check the housing for cracks. Replace if cracked.
- 11.** Ensure the rollers turn freely. Replace the roller assembly if the rollers are seized or worn or if there is a reduction or lack of output from the pump. *Illustration G*
- 12.** Reinstall clean tube housing.
- 13.** Apply AquaShield™ to the shaft tip.
- 14.** Install the roller assembly.

# TUBE REPLACEMENT continued

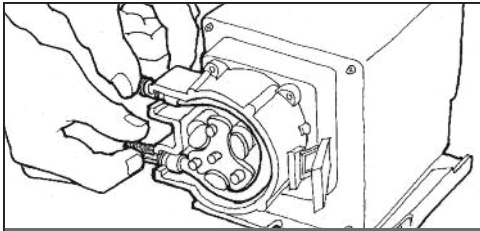

**H Place new tube**

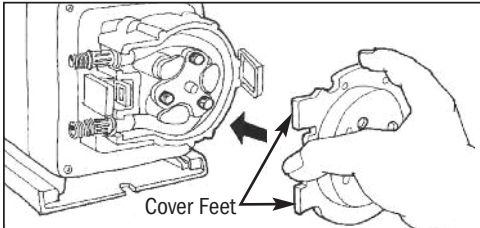

**I Install cover feet first**

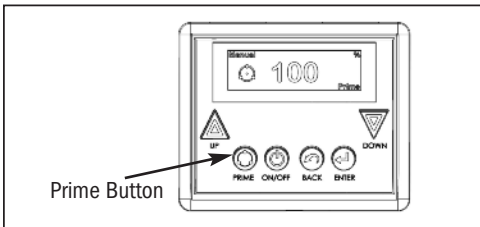

**J Depress the prime button**

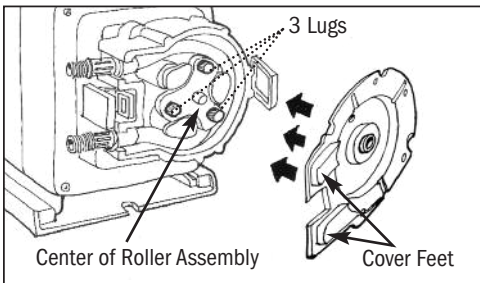

**K Align cover feet near bottom**

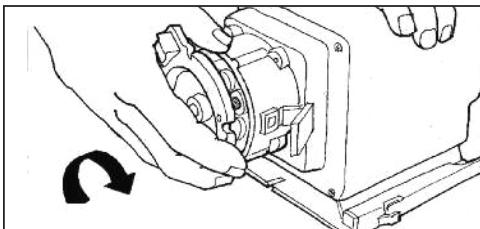

**L Expand roller assembly**

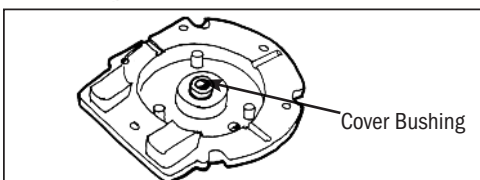

**M Apply Aquashield™ to cover bushing**

## INSTALL THE TUBE/ EXPAND THE ROLLER ASSEMBLY

1. Ensure the power to the pump is off and the input signal is disconnected.
2. Place the new tube in the pump head, use your fingers to ensure that it is centered over the rollers. *Illustration H*
3. Place the tube housing cover (feet first) on the tube housing, affix the front of the latches to the cover lip and then press the latches back to secure. Be sure the cover is seated with the sleeve bearing on the shaft and is flush with the housing before latching. *Illustration I*
4. With the cover latched, plug the pump in. Depress the prime button to allow the pump to run the roller assembly in its collapsed position for one minute to relax tube. *Illustration J*
5. Unplug the power cord to ensure the power to the pump is off.
6. Remove the tube housing cover and flip to use as a tool in the next step.

7. Align the center of the inverted cover with the center of the roller assembly so that the three holes on the face of the cover align with the three knurled lugs on the roller assembly. Position the cover feet near the bottom. *Illustration K*

NOTE: The roller assembly needs to be expanded so the tube is pressed against the tube housing wall.

8. Hold the pump securely. Use the cover as a wrench and quickly (snap) rotate the roller assembly clockwise to expand the roller assembly. The tube will be pressed against the tube housing wall. *Illustration L*

NOTE: Clockwise is viewed from facing the head of the pump.

9. Apply a small amount of AquaShield™ to the cover bushing ONLY. DO NOT lubricate the pump tube. *Illustration M*
10. Place the tube housing cover (feet first) on the tube housing, affix the front of the latches to the cover lip and then press the latches back to secure. Be sure the cover is seated with the sleeve bearing on the shaft and is flush with the housing before latching. *Illustration I*

# TUBE REPLACEMENT continued

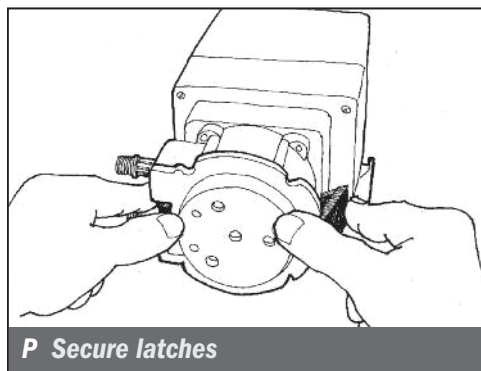
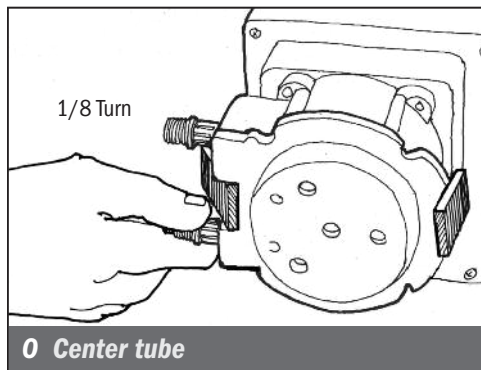
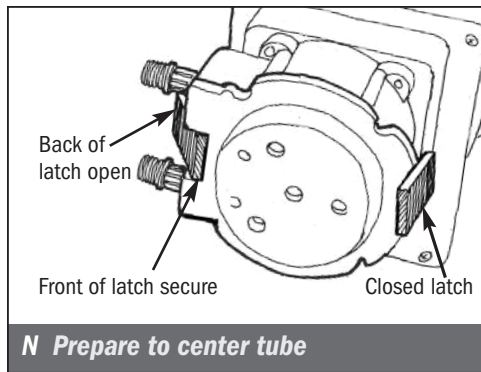

## CENTER THE TUBE

1. Lift the latch located between the tube fittings, leaving the end of the latch engaged with the lip on the tube housing cover. Leave the latch on the opposite side engaged. *Illustration N*
2. Plug the pump in. Depress the prime button and turn the tube fitting on the suction side not more than 1/8 of a turn in the direction the tube must move *Illustration O*
3. Do not let go of the fitting until the tube rides approximately in the center of the rollers.
4. Release the prime button, let go of the fitting, and secure the latch between the fittings. *Illustration P*
5. Inspect the suction and discharge lines, point of injection, and check valve duckbill for blockages. Clean and/or replace as required.
6. Reconnect the suction and discharge lines.
7. Prime pump and verify operation.
8. Place pump in desired operating mode.

# CLEANING THE POINT OF INJECTION – SAFETY INFORMATION

**NOTICE:** Indicates special instructions or general mandatory action.

**NOTICE:** Low-pressure models are installed using an injection fitting and high-pressure models use an injection check valve. Both allow the extension tip to be installed in the center of the pipe directly in the flow of water to help reduce deposit accumulation.

**WARNING** Warns about hazards that CAN cause death, serious personal injury, or property damage if ignored.

This is the safety alert symbol. When displayed in this manual or on the equipment, look for one of the following signal words alerting you to the potential for personal injury or property damage.

**WARNING** HAZARDOUS PRESSURE/CHEMICAL EXPOSURE:

Use caution and bleed off all resident system pressure prior to attempting service or installation.

Use caution when disconnecting discharge line from pump. Discharge line may be under pressure. Discharge line may contain chemical.

To reduce risk of exposure, the use of proper personal protective equipment is mandatory when working on or near chemical metering pumps.

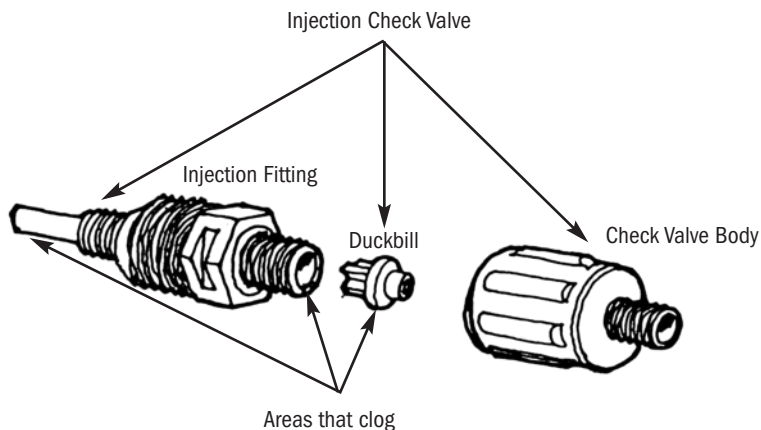

# CLEANING THE POINT OF INJECTION continued

1. Disconnect power by unplugging pump power cord. Disable water pump or auxiliary equipment electrical supply.
2. Depressurize system and bleed pressure from pump discharge line.
3. Loosen and remove connecting nut and ferrule from the injection check valve or injection fitting to disconnect discharge line.

## 100 psi max. Model (includes injection check valve)

- Unscrew the top fitting (check valve body) to disassemble. The bottom fitting (injection fitting with arrow) should remain attached to the pipe.
- Remove duckbill from check valve body and replace if deteriorated or swollen (replace duckbill with every tube change). If clogged, clean or replace.
- Examine O-ring in the injection fitting and replace if deteriorated or damaged.

4. Insert a #2 Phillips head screwdriver through injection fitting into the pipe to locate or break up accumulated deposits. If screwdriver cannot be inserted, drill the deposit out of the injection fitting. (DO NOT drill through the opposite pipe wall.)
5. Replace discharge line if cracked or deteriorated. If the end is clogged, cut off the calcified or blocked section of discharge line.

## 25 psi max. Model (includes injection fitting)

Replace ferrule and reinstall the discharge line to the injection fitting approximately 3/4"-1" until it stops.

## 100 psi max. Model (includes injection check valve)

- Reassemble the injection check valve in reverse order.
- Replace ferrule and reinstall the discharge line to the injection check valve approximately 3/4" until it stops.

6. Tighten the connecting nut finger tight.
7. Enable the water pump electrical supply and pressurize the water system.
8. Put the metering pump back in service and inspect all connections for leaks.

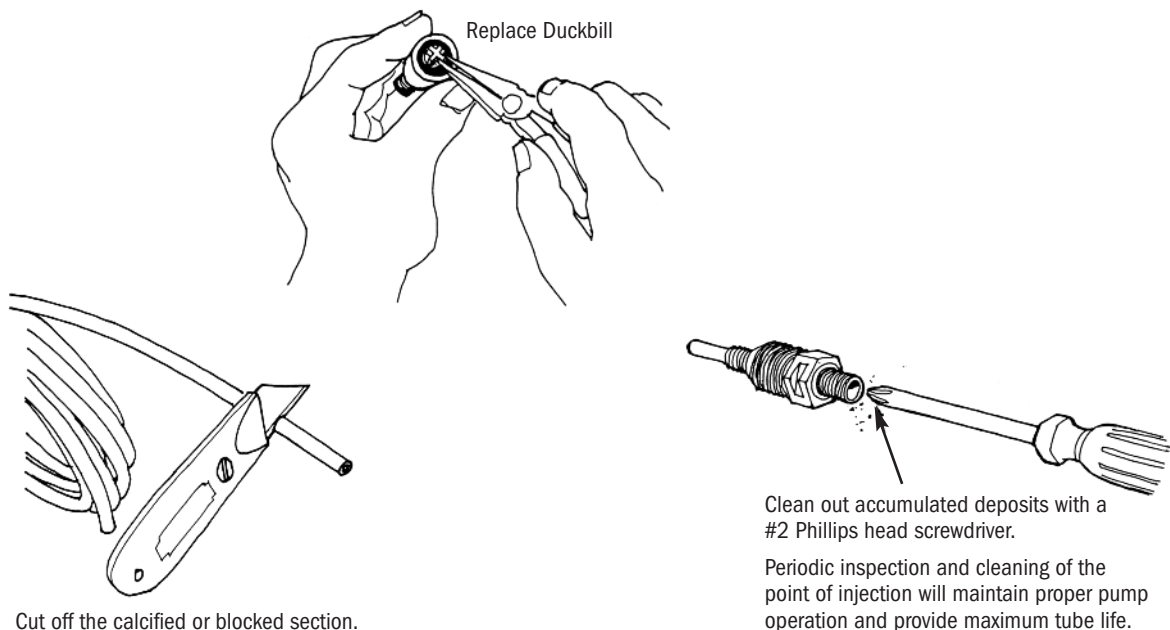

# PUMP HEAD PARTS

QP Tube Housing with Leak Detect and Latches

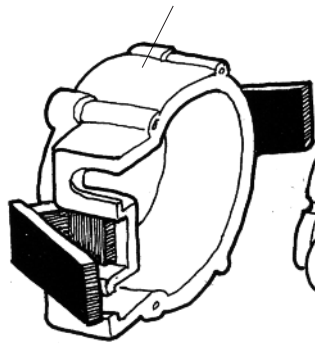

QP Roller Assembly with Spline

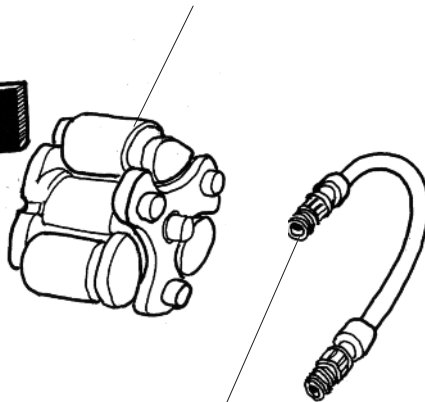

Pump Tube  
refer to p99

QP Tube Housing Cover with Leak Detect



PART NUMBER	UM	DESCRIPTION
S3400-1 S3400-2	EA 2-PK	QP Tube Housing with Leak Detect and Latches
S3500-1 S3500-4	EA 4-PK	QP Roller Assembly with Spline
S3600-1 S3600-4	EA 4-PK	QP Tube Housing Cover with Leak Detect
QP401-2	2-PK	QP Latches only
QP501-3	EA	QP Roller Arm Assembly includes arms, bushings, rollers, screws



# PUMP HEADS – QuickPro® WITH LEAK DETECT

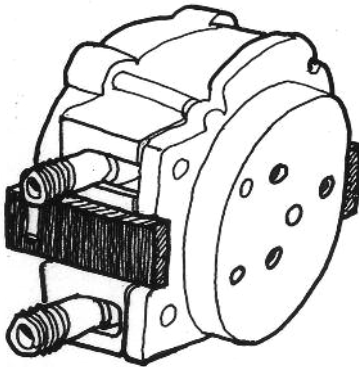

Pump Tube Pressure Rating

Pump Tube	25 psi (1.7 bar) max.	100 psi (6.9 bar) max. Check valve required
1	✓	✓
2	✓	✓
3	✓	
4	✓	
5	✓	
7		✓

**25 psi (1.7 bar) MAX.** Includes leak detect pump head, tube, ferrules 1/4" (EUROPE 6 mm)

PART NUMBER	UM	DESCRIPTION
S310■-1 S310■-2	EA 2-PK	Select Santoprene® tube # 3, 4 or 5 for ■
S320■-1	EA	Select Versilon® tube # 3, 4 or 5 for ■

**EUROPE**

S315■-1 S315■-2	EA 2-PK	Select Santoprene® tube # 3, 4 or 5 for ■
S325■-1	EA	Select Versilon® tube # 3, 4 or 5 for ■

**100 psi (6.9 bar) MAX.** Includes leak detect pump head, tube, duckbill, ferrules 1/4" (EUROPE 6 mm)

PART NUMBER	UM	DESCRIPTION
S310■-1 S310■-2	EA 2-PK	Select Santoprene® tube # 1, 2 or 7 for ■
S320■-1	EA	Select Versilon® tube # 1 or 2 for ■

**EUROPE**

S315■-1 S315■-2	EA 2-PK	Select Santoprene® tube # 1, 2 or 7 for ■
S325■-1	EA	Select Versilon® tube # 1 or 2 for ■

\* Confirm material compatibility with the chemical resistance guide in the catalog. Santoprene® is beige, Versilon® and Pellethane® are clear.

# PUMP HEAD SERVICE KITS

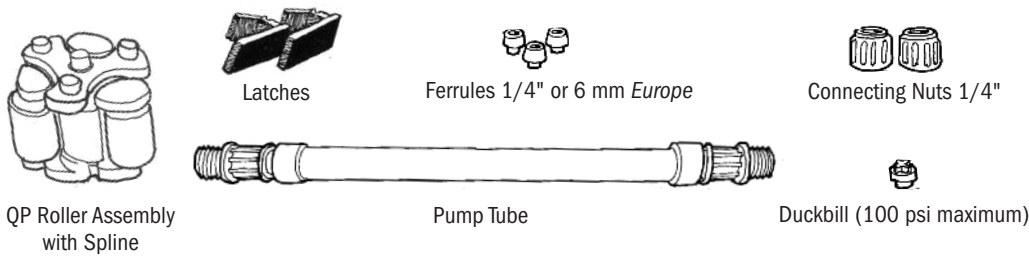

**25 psi (1.7 bar) MAX.** Kit includes parts as shown, duckbill not included

PART NUMBER	UM	DESCRIPTION
S310■K	KIT	Kit-Select Santoprene® tube # 3, 4 or 5 for ■
S320■K	KIT	Kit-Select Versilon® tube # 3, 4 or 5 for ■

**EUROPE**

S311■K	KIT	Kit-Select Santoprene® tube # 3, 4 or 5 for ■
S321■K	KIT	Kit-Select Versilon® tube # 3, 4 or 5 for ■

**100 psi (6.9 bar) MAX.** Kit includes parts as shown

PART NUMBER	UM	DESCRIPTION
S310■K	KIT	Kit-Select Santoprene® tube # 1, 2 or 7 for ■
S320■K	KIT	Kit-Select Versilon® tube # 1 or 2 for ■

**EUROPE**

S311■K	KIT	Kit-Select Santoprene® tube # 1, 2 or 7 for ■
S321■K	KIT	Kit-Select Versilon® tube # 1 or 2 for ■

\* Confirm material compatibility with the chemical resistance guide in the catalog. Santoprene® is beige, Versilon® and Pellethane® are clear.

# PUMP TUBES

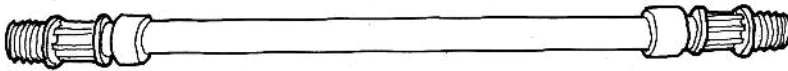

Includes ferrules 1/4" (EUROPE 6 mm)

PART NUMBER	UM	DESCRIPTION
UCCP20 ■ MCCP20 ■	2-PK 5-PK	Santoprene® tube select # 1, 2, 3, 4 or 5 for ■
UCCP207 MCCP207	2-PK 5-PK	Santoprene® #7 tube
UCTYGO ■ MCTYGO ■	2-PK 5-PK	Versilon® tube select # 1, 2, 3, 4 or 5 for ■

## EUROPE

UCCP2 ■CE MCCP2 ■CE	2-PK 5-PK	Santoprene® tube select # 1, 2, 3, 4 or 5 for ■
UCCP27CE MCCP27CE	2-PK 5-PK	Santoprene® #7 tube
UCTY ■CE MCTY ■CE	2-PK 5-PK	Versilon® tube select # 1, 2, 3, 4 or 5 for ■

Includes duckbills, ferrules 1/4" (EUROPE 6 mm)

PART NUMBER	UM	DESCRIPTION
UCCP ■FD	2-PK	Santoprene® tube # 1 or 2 for ■
UCCP7FD	2-PK	Santoprene® #7 tube
UCTY ■FD	2-PK	Versilon® tube select # 1 or 2 for ■

## EUROPE

UC ■FDCE	2-PK	Santoprene® tube select # 1 or 2 for ■
UC7FDCE	2-PK	Santoprene® #7 tube
UCTY ■DCE	2-PK	Versilon® tube select # 1 or 2 for ■

\* Confirm material compatibility with the chemical resistance guide in the catalog. Santoprene® is beige, Versilon® and Pellethane® are clear.

Refer to the Flow Rate Output Chart to match the pump model with the correct tube.

# CHECK VALVES



Injection Check Valve 1/4"



Injection Check Valve 3/8"



Injection Check Valve 6 mm

## FOR 100 psi (6.9 bar) MAX. PUMPS

PART NUMBER	UM	DESCRIPTION
UCDBINJ MCDBINJ	EA 5-PK	Check Valve includes Santoprene® duckbill ferrule 1/4"
UCTYINJ MCTYINJ	EA 5-PK	Check Valve includes Pellethane® duckbill, ferrule 1/4"
UCINJ38 MCINJ38	EA 5-PK	Check Valve includes Santoprene® duckbill, ferrule 3/8"
UCTYIJ38 MCTYU38	EA 5-PK	Check Valve includes Pellethane® duckbill, ferrule 3/8"

## EUROPE

UCINJCE MCINJCE	EA 5-PK	Check Valve includes Santoprene® duckbill, ferrule 6 mm
UCTINJCE MCTINJCE	EA 5-PK	Check Valve includes Pellethane® duckbill, ferrule 6 mm

\* Confirm material compatibility with the chemical resistance guide in the catalog. Santoprene® is beige, Versilon® and Pellethane® are clear.

# WALL MOUNT BRACKET MOUNTING HOLE DIMENSIONS

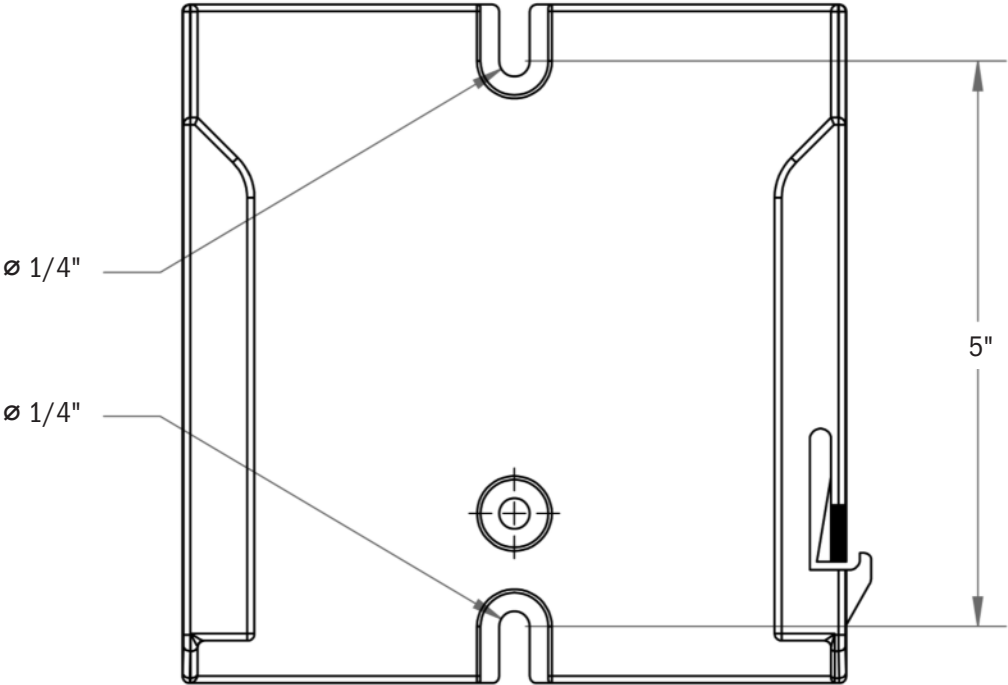

**NOTICE:** Leave 8" of clearance above pump to allow for removal from mounting bracket.



**STENNER PUMP COMPANY**

3174 DeSalvo Road  
Jacksonville, Florida 32246  
USA

Phone: 904.641.1666  
US Toll Free: 800.683.2378  
Fax: 904.642.1012

[sales@stenner.com](mailto:sales@stenner.com)  
[www.stenner.com](http://www.stenner.com)

Hours of Operation (EST):  
Mon.-Thu. 7:30 am-5:30 pm  
Fri. 7:00 am-5:30 pm

 Assembled in the USA

© Stenner Pump Company  
All Rights Reserved