

S SERIES FW 5.01.02

PERISTALTIC METERING PUMPS

INSTALLATION AND MAINTENANCE MANUAL

PPM FEED - VARIABLE FLOW, HALL EFFECT

and MANUAL Control Modes

 **WARNING**

TO BE INSTALLED AND MAINTAINED BY PROPERLY TRAINED PROFESSIONAL INSTALLER ONLY. READ MANUAL & LABELS FOR ALL SAFETY INFORMATION & INSTRUCTIONS.

TABLE OF CONTENTS

Warranty And Service Policy 3

Safety Instructions Cover, 4-6, 8, 18, 34, 38-41, 47-49, 52, 53, 55-59, 63-64, 69-71

Flow Rate Outputs 6

Materials of Construction..... 7

Chemical Resistance Guide..... 8-9

Accessories..... 10

General Information..... 11-13

Modbus Requirements 13

Configuration 14-30

Control Modes.....31-36

Operating Display.....37-41

Connections42-51

Installation..... 52-58

Troubleshooting..... 59-63

Tube Replacement..... 64-70

Cleaning The Point Of Injection 71-72

Parts.....73-77

Wall Mounting Bracket Dimensions.....78

SERIES	S SERIES multiple operational modes and indicators		
MODEL	pump head-plastic latches S30	pump head-3 thumbscrews S40	pump head-4 thumbscrews S50

IMS 010925
FW 5.01.02

WARRANTY AND CUSTOMER SERVICE

LIMITED WARRANTY

Stenner Pump Company will for a period of 2 years from the date of purchase (proof of purchase required) repair or replace, at our option, all defective parts. Stenner is not responsible for any removal or installation costs. Pump tube assemblies and rubber components are considered perishable and are not covered in this warranty. Pump tube will be replaced each time a pump is in for service, unless otherwise specified. The cost of the pump tube replacement will be the responsibility of the customer. Stenner will incur shipping costs for warranty products shipped from our factory. Any tampering with major components, chemical damage, faulty wiring, weather conditions, water damage, power surges, or products not used with reasonable care and maintained in accordance with the instructions will void the warranty. Stenner limits its liability solely to the cost of the original product. We make no other warranty expressed or implied.

RETURNS

Stenner offers a 30-day return policy on factory direct purchases. Except as otherwise provided, no merchandise will be accepted for return after 30 days from purchase. To return merchandise at any time, call Stenner at 800.683.2378 for a Return Merchandise Authorization (RMA) number. A 15% re-stocking fee will be applied. Include a copy of your invoice or packing slip with your return.

DAMAGED OR LOST SHIPMENTS

Check your order immediately upon arrival. All damage must be noted on the delivery receipt. Call Stenner Customer Service at 800.683.2378 for all shortages and damages within seven (7) days of receipt.

SERVICE & REPAIRS

Before returning a pump for warranty or repair, remove chemical from pump tube by running water through the tube, and then run the pump dry. Following expiration of the warranty period, Stenner Pump Company will clean and overhaul any Stenner metering pump for a minimum labor charge plus necessary replacement parts and shipping. All metering pumps received for overhaul will be restored to their original condition. The customer will be charged for missing parts unless specific instructions are given. To return merchandise for repair, call Stenner at 800.683.2378 or 904.641.1666 for a Return Merchandise Authorization (RMA) number.

DISCLAIMERS

The information in this manual is not intended for specific purposes.

The Stenner Pump Company reserves the right to make changes to prices, products, and specifications at any time without prior notice.

The Modbus communication protocol is a product of the Modbus Organization, www.modbus.org.

TRADEMARKS

QuickPro® is a registered trademark of the Stenner Pump Company.

Santoprene® is a registered trademark of Celanese International Corporation.

Versilon® is a registered trademark of Saint-Gobain Performance Plastics.

Pellethane® is a registered trademark of Lubrizol Advanced Materials, Inc.

Hastelloy® is a registered trademark of Haynes International, Inc.

SAFETY INSTRUCTIONS

IMPORTANT SAFETY INSTRUCTIONS

When installing and using this electrical equipment, basic safety precautions should always be followed, including the following:

READ AND FOLLOW ALL INSTRUCTIONS

 **WARNING** Warns about hazards that CAN cause death, serious personal injury, or property damage if ignored.

 **WARNING** ELECTRIC SHOCK HAZARD

 **WARNING** RISK OF ELECTRIC SHOCK

Connect only to a branch circuit protected by a ground-fault circuit-interrupter (GFCI). Contact a qualified electrician if you cannot verify that the receptacle is protected by a GFCI.

 **AVERTISSEMENT** RISQUE DE CHOC ELECTRIQUE

Brancher seulement à un réseau électrique protégé par un DDFT. Contactez un électricien certifié si vous ne pouvez pas vérifier que la prise est protégé par un DDFT.

 **PELIGRO** PELIGRO DE DESCARGA ELECTRICA

Conecte a un circuito en derivación protegido por un interruptor de descarga a tierra (GFCI). Contacte a un electricista certificado si no puede verificar que su receptáculo esté protegido por dicho interruptor (GFCI).

 **WARNING** To reduce the risk of electric shock, replace damaged cord immediately. Contact the factory or an authorized service facility for repair.

 **WARNING** **DO NOT** alter the power cord or plug end. **DO NOT** use receptacle adapters.

 **WARNING** **DO NOT** use pump with a damaged or altered power cord or plug. Contact the factory or authorized service facility for repair.

 **WARNING** After installation, the power supply plug must be accessible during use.

 **WARNING** To reduce the risk of injury, do not permit children to use this product. This appliance is not to be used by persons with reduced physical, sensory or mental capabilities, or lack of experience and knowledge, unless they have been given supervision or instruction.

 **WARNING** This pump has not been investigated for use in marine areas.

 **AVERTISSEMENT** La pompe n'a pas été vérifiée et approuvée pour utilisation sur des applications de installation marine.

 **PELIGRO** Este dosificador no ha sido investigado para uso en áreas marinas.

 **WARNING** EXPLOSION HAZARD

This equipment **IS NOT** explosion proof. **DO NOT** install in an explosive environment.

 **WARNING** RISK OF CHEMICAL EXPOSURE AND OVERDOSE

Potential for chemical burns, fire, explosion, personal injury, or property damage. To reduce risk of exposure, the use of proper personal protective equipment is mandatory. To reduce risk of overdosing, follow proper installation methods and recommendations. Check your local codes for additional guidelines.

 **WARNING** RISK OF FIRE HAZARD

DO NOT install or operate on any flammable surface.

 **WARNING** Pump is not recommended for installation in areas where leakage can cause personal injury or property damage.

SAFETY INSTRUCTIONS continued

 **CAUTION** Warns about hazards that **WILL** or **CAN** cause minor personal injury or property damage if ignored.

 **CAUTION** To reduce risk of electric shock, pull plug before servicing this pump.

 **CAUTION** This pump has been evaluated for use with water only.

 **CAUTION** Non-submersible pump. Suitable for indoor and outdoor use.

 **ATTENTION** Pompe non submersible. Adaptée à une utilisation aussi bien à l'intérieur qu'à l'extérieur.

 **CUIDADO** Dosificador no sumergible. Adecuado para el uso interior y exterior.

 **CAUTION PLUMBING**

Chemical feed pump installation must always adhere to your local plumbing codes and requirements. Be sure installation does not constitute a cross connection. Check local plumbing codes for guidelines.

 **CAUTION** Electrical installation should adhere to all national and local codes. Consult licensed professional for assistance with proper electrical installation.

 **CAUTION** Pump uses a class 2 switching power supply.

 **CAUTION PINCH POINT HAZARD**

Use extreme caution when replacing pump tube. Be careful of your fingers and do not place fingers near rollers.

SAVE THESE INSTRUCTIONS

 **NOTICE: Indicates special instructions or general mandatory action.**

 This metering pump is portable and designed to be removable from the plumbing system without damage to the connections.

 This metering pump and its components have been tested for use with the following chemicals; Sodium Hypochlorite (10-15%), Muriatic Acid (20-22 Baume, 31.5% HCl), and Soda Ash.

 Cette a pompe de dosage et ses composants ont été testés pour utilisation avec les produits chimiques suivants; Hypochlorite de Sodium (solution de 10-15%); Acide Muriatique (20-22 Baume, 31.5% HCl); Cendre de Soude.

 Before installing or servicing the pump, read the pump manual for all safety information and complete instructions. The pump is designed for installation and service by properly trained personnel.

 No user replaceable parts inside.

 INTERTEK/ETL Tested for CE, IP65 rated pumps only, maximum altitude 2000 m.

FLOW RATE OUTPUTS

25 psi (1.7 bar) max.

Pump Prefix	Tube	Turndown Ratio	Gallons per Day	Gallons per Hour	Ounces per Hour	Ounces per Minute	Liters per Day	Liters per Hour	Milliliters per Hour	Milliliters per Minute
S3003	3	100:1	0.40-40.0	0.017-1.67	2.13-213.0	0.036-3.56	1.51-151.0	0.063-6.31	63.09-6309.0	1.05-105.0
S3004	4	100:1	0.60-60	0.025-2.50	3.20-320.0	0.053-5.33	2.27-227.0	0.095-9.46	94.64-9464.0	1.58-158.0
S3005	5	100:1	0.85-85	0.035-3.54	4.53-453	0.076-7.56	3.22-322	0.134-13.41	134.07-13407	2.23-223
S405X	5X	100:1	1.5-150.0	0.06-6.25	8.0-800.0	0.13-13.33	5.7-567.0	0.24-23.66	236.59-23,659.0	3.94-394.0
S505G	5G	100:1	3.2-315.0	0.133-13.13	17.07-1680.0	0.284-28.00	12.11-1192.0	0.505-49.68	504.72-49,684.0	8.41-828.0
Approximate output @ 50/60Hz										

100 psi (6.9 bar) max.

Pump Prefix	Tube	Turndown Ratio	Gallons per Day	Gallons per Hour	Ounces per Hour	Ounces per Minute	Liters per Day	Liters per Hour	Milliliters per Hour	Milliliters per Minute
S3001	1	100:1	0.05-5.0	0.002-0.21	0.27-27.0	0.004-0.44	0.19-19.0	0.008-0.79	7.89-789.0	0.13-13.0
S3002	2	100:1	0.17-17.0	0.007-0.71	0.91-91.0	0.015-1.51	0.64-64.0	0.027-2.68	26.81-2681.0	0.45-45.0
S3007	7	100:1	0.40-40.0	0.017-1.67	2.13-213.0	0.036-3.56	1.51-151.0	0.063-6.31	63.09-6309.0	1.05-105.0
S407X	7X	100:1	0.60-60.0	0.03-2.50	3.2-320.0	0.053-5.34	2.3-227.0	0.09-9.46	94.64-9464.0	1.58-158.0
S507G	7G	100:1	1.3-125.0	0.054-5.21	6.93-667.0	0.116-11.11	4.92-473.0	0.205-19.72	205.04-19,716.0	3.42-329.0
Approximate output @ 50/60Hz										

NOTICE: The information within this chart is solely intended for use as a guide. The output data is an approximation based on pumping water under a controlled testing environment. Many variables can affect the output of the pump. Stenner Pump Company recommends that all metering pumps undergo field calibration by means of analytical testing to confirm their outputs.

MATERIALS OF CONSTRUCTION

All Housings Polycarbonate

Pump Tube

S30 Santoprene® (FDA approved) or Versilon®

S40, S50 Santoprene® (FDA approved)

Check Valve Duckbill **S30** Santoprene® (FDA approved) or Pellethane®

Ball Check Valve Components **S40, S50**

- Ceramic ball (FDA approved); Tantalum spring; FKM seat & O-ring **or**
- Ceramic ball (FDA approved); Stainless steel spring; EPDM seat; Santoprene® O-ring

Pump Head Rollers

S30, S40 Polyethylene

S50 Polycarbonate

Pump Head Guide Rollers **S40, S50** Polyethylene

Roller Bushings **S30, S40** Oil impregnated bronze

Roller Ball Bearings **S50** Stainless steel

Suction/Discharge Lines, Ferrules Polyethylene (FDA approved)

Tube Fittings, Injection Fittings PVC or Polypropylene (both NSF listed)

Connecting Nuts PVC or Polypropylene (both NSF listed)

3/8" Adapter **S30** PVC or Polypropylene (both NSF listed)

Suction Line Strainer and Cap PVC or Polypropylene (both NSF listed); ceramic weight

All Fasteners Stainless steel

Pump Head Latches **S30** Polypropylene

Pump Head Thumbscrews **S40, S50** Stainless steel; PVC

Pump Head Support and Transition Sleeve **S40, S50** Santoprene®

Tube Pull **S40, S50** PVC

Leak Detect Components

S30 Hastelloy®

S40, S50 Hastelloy®; stainless steel

CHEMICAL RESISTANCE GUIDE

Ratings Key – Chemical Effect

- A** Fluid has minor or no effects
- B** Fluid has minor to moderate effects
- C** Fluid has severe effects
- No data available



CAUTION

The information is provided ONLY as a guide to assist in determining chemical compatibility for wetted components. Testing under the specific conditions of the application is recommended. Stenner Pump Company assumes no responsibility for its accuracy. Outside factors including but not limited to temperature, pressure, mechanical stress, and solution concentration can affect material compatibility in a particular application. Stenner makes no warranty, expressed or implied, as to the accuracy of this guide or any materials' suitability for fitness or purpose for any application. User assumes all risk and liability for use of this guide.

Chemical / Solution	PP Santoprene EPDM	Versilon [®]	PVC	LDPE	FKM	Silicone	Tantalum	Stainless Steel
Acetic Acid 20%	A	B	B	A	B	A	A	A
Acetic Acid 30%	B	C	C	A	B	A	A	B
Acetic Acid, Glacial	C	C	C	C	C	·	A	A
Acetic Anhydride	B	C	C	C	C	C	·	A
Aliphatic Hydrocarbons	B	B	B	B	·	·	·	·
Aluminum Chloride	A	A	A	B	A	B	A	B
Aluminum Sulfate	A	A	A	A	A	A	A	B
Alums	A	A	A	A	A	A	·	A
Ammonium Acetate	B	B	A	A	A	·	·	A
Ammonium Carbonate	A	A	A	A	A	C	·	B
Ammonium Chloride	A	B	A	B	A	C	A	B
Ammonium Hydroxide	A	B	A	A	B	A	B	A
Ammonium Nitrate	A	A	A	A	B	C	A	A
Ammonium Phosphate	A	A	A	A	A	A	·	C
Ammonium Sulfate	A	A	A	A	B	A	A	B
Amyl Acetate	A	C	C	C	C	C	·	A
Aniline	B	C	C	C	C	C	A	B
Antimony Salts	A	A	A	B	·	·	·	·
Arsenic Salts	A	A	A	B	·	·	·	·
Barium Hydroxide	A	A	A	B	A	·	B	B
Barium Salts	A	·	A	B	·	A	·	·
Beer	A	A	A	A	A	·	A	A
Benzene	C	C	C	C	B	·	·	B
Benzoic Acid	A	C	A	A	A	·	A	B
Bleach 5.25%	A	A	A	A	A	·	·	·
Boric Acid	A	A	A	A	A	A	A	A
Bromine	A	B	B	B	A	C	A	C
Butyl Acetate	A	C	C	C	C	C	·	A
Butyric Acid	A	C	B	C	B	C	A	B
Calcium Chloride	A	A	B	A	A	·	A	B
Calcium Hydroxide	A	C	A	A	A	·	B	B
Calcium Hypochlorite 5%	A	B	A	A	A	·	A	B
Calcium Salts	A	A	A	A	·	B	·	·
Carbon Disulfide	C	C	C	C	A	·	·	B
Carbon Tetrachloride	C	C	C	C	A	C	·	B
Castor Oil	B	A	A	·	A	·	·	A
Chlorine	see Sodium Hypochlorite							

Chemical / Solution	PP Santoprene EPDM	Versilon [®]	PVC	LDPE	FKM	Silicone	Tantalum	Stainless Steel
Chloroacetic Acid	A	C	B	C	C	·	·	A
Chloroform	C	C	C	C	A	C	·	A
Chlorosulfonic Acid	B	C	C	C	C	C	·	B
Chromic Acid < 50%	B	C	B	A	A	C	A	B
Chromium Salts	A	·	A	B	·	·	·	·
Citric Acid	B	B	B	C	A	·	A	A
Copper Chloride	A	A	A	A	A	·	A	C
Copper Sulfate	A	A	A	A	A	·	A	B
Cottonseed Oil	B	A	B	A	A	·	·	A
d-Limonene	C	B	B	B	A	C	·	·
Ethyl Acetate	A	C	C	C	C	B	·	B
Ethyl Alcohol	B	C	C	B	B	·	A	·
Ethyl Chloride	C	C	C	C	A	C	·	A
Ethylene Dichloride	C	C	C	C	A	C	·	B
Ethylene Glycol	A	A	A	A	A	A	·	B
Ethylene Oxide	B	A	C	C	C	C	·	B
Eucalyptus Oil	C	B	C	C	·	·	·	·
Fatty Acids	C	B	A	A	A	C	·	A
Ferric Chloride	A	A	A	A	A	B	A	C
Ferric Sulfate	A	A	A	A	A	B	·	B
Ferrous Chloride	A	A	A	A	A	C	·	C
Ferrous Sulfate	A	A	A	A	A	C	·	B
Fluoboric Acid	A	C	A	C	B	A	·	·
Fluosilicic Acid	A	A	A	A	A	C	·	B
Formaldehyde < 40%	A	B	A	C	C	B	·	A
Formic Acid	A	C	B	C	C	C	A	A
Glucose	A	A	A	A	A	A	·	A
Glycerin	A	A	A	A	A	A	·	A
Hydrochloric Acid 20%	A	C	A	A	A	C	A	C
Hydrochloric Acid 37%	A	C	A	A	A	C	A	C
Hydrocyanic Acid	A	B	A	A	A	C	A	A
Hydrofluoric Acid < 48%	A	C	B	A	A	C	C	C
Hydrofluoric Acid 48-75%	A	C	C	C	A	C	C	C
Hydrofluoric Acid, anhydrous	B	C	C	C	C	·	C	C
Hydrogen Peroxide < 50%	A	B	A	B	A	A	A	A
Hydrogen Sulfide	A	A	B	A	C	·	·	A
Iodine	A	A	C	B	A	C	A	C

Chemical / Solution	PP Santoprene EPDM	Versilon	PVC	LDPE	FKM	Silicone	Tantalum	Stainless Steel
Lactic Acid	A	B	B	A	A	A	A	B
Lead Acetate	B	A	A	A	C	C	·	B
Linseed Oil	B	A	A	A	A	A	·	A
Limonene	C	B	B	B	A	C	·	·
Lubricating Oils	C	A	B	C	A	·	·	A
Magnesium Chloride	A	A	B	A	A	A	A	C
Magnesium Hydroxide	A	A	A	A	A	·	A	A
Magnesium Sulfate	A	A	A	A	A	A	A	B
Malic Acid	A	B	A	A	A	B	·	A
Manganese Salts	A	A	A	A	·	B	·	·
Mercuric Chloride	A	A	A	A	A	·	·	C
Methylene Chloride	C	C	C	C	B	·	A	B
Mineral Oil	B	A	B	B	A	·	·	·
Mineral Spirits	C	A	B	B	A	·	·	A
Muriatic Acid, 20° Baume	A	C	A	A	A	·	·	·
Nckel Chloride	B	C	A	B	A	A	A	B
Nickel Sulfate	A	A	A	A	A	A	A	A
Nitric Acid < 10%	A	C	A	B	A	B	A	A
Nitric Acid 10-30%	B	C	A	C	A	C	A	A
Nitric Acid 30-60%	C	C	B	C	A	C	A	A
Nitric Acid 70%	C	C	B	C	A	C	A	A
Nitric Acid, red fuming	C	C	C	C	C	C	·	·
Nitrous Acid	A	B	·	·	B	·	·	B
Oleic Acid	A	B	C	C	B	C	·	A
Oleum 20-25%	C	C	C	C	·	·	·	B
Oxalic Acid	A	C	B	A	A	C	A	A
Palmitic Acid	A	B	B	A	A	C	·	A
Petroleum Distillates	C	B	B	C	·	·	A	A
Peracetic Acid 5%	B	B	B	A	A	A	·	·
Peracetic Acid 15%	B	B	B	A	A	B	·	·
Phenol	B	C	C	B	A	C	·	B
Phosphoric Acid	A	C	A	A	A	C	A	C
Phthalic Acid	A	C	A	A	A	B	·	A
Pickling Solutions	A	C	·	·	B	·	·	·
Plating Solutions	A	C	·	·	A	C	·	·
Polyphosphate	A	A	A	A	·	·	·	·
Potassium Carbonate	A	A	A	A	A	·	·	B
Potassium Chlorate	A	A	A	A	A	B	·	B
Potassium Hydroxide	A	A	A	A	C	C	B	A
Potassium Dichromate	A	A	A	A	A	·	·	B
Potassium Iodide	A	A	B	B	A	·	·	A
Potassium Permanganate	A	A	A	A	A	·	·	B

Chemical / Solution	PP Santoprene EPDM	Versilon	PVC	LDPE	FKM	Silicone	Tantalum	Stainless Steel
Sea Water	A	A	A	A	A	·	A	C
Silicone Oil	C	A	A	B	A	C	·	A
Silver Nitrate	A	A	A	A	A	A	·	B
Soap Solutions	A	A	A	C	A	A	·	A
Sodium	A	A	A	A	·	·	·	·
Sodium Bisulfate	A	A	A	A	A	·	·	C
Sodium Bisulfite	A	A	A	A	A	A	·	B
Sodium Borate	A	A	A	A	A	A	·	B
Sodium Carbonate	A	A	A	A	A	A	·	A
Sodium Chlorate	A	A	A	A	A	C	·	B
Sodium Chloride	A	A	A	A	A	A	A	B
Sodium Dichromate 20%	A	·	B	·	A	·	·	·
Sodium Hydroxide < 20%	A	B	A	B	C	A	B	B
Sodium Hydroxide 20-46.5%	A	C	A	B	C	·	C	B
Sodium Hypochlorite 5%	A*	B	A	A	A	B	A	C
Sodium Hypochlorite 6-15%	A*	B	A	A	A	B	A	C
Sodium Nitrate	A	A	A	A	A	C	A	B
Sodium Silicate	A	A	A	A	A	A	·	B
Sodium Sulfide	A	A	A	A	A	A	·	C
Sodium Sulfite	A	A	A	A	A	A	·	A
Solvents	C	B	B	B	·	·	·	·
Soybean Oil	B	A	A	A	A	·	·	A
Stannous Chloride 15%	A	A	A	B	A	·	·	A
Stearic Acid	A	B	B	B	A	B	·	A
Sulfur Dioxide liquid	A	C	C	C	B	·	·	A
Sulfur Trioxide	B	C	A	C	A	·	·	C
Sulfuric Acid < 40%	B	B	B	B	A	C	A	C
Sulfuric Acid > 40%	C	C	C	C	A	C	A	C
Sulfurous Acid	A	A	A	B	C	C	·	B
Tannic Acid 10%	A	B	A	B	A	B	·	A
Tanning Liquors	A	A	A	A	A	·	·	A
Tartaric Acid	A	A	A	A	A	A	·	C
Titanium Salts	A	A	A	B	·	·	·	·
Triethanolamine	A	C	C	C	C	·	·	·
Trisodium Phosphate	A	A	A	A	A	·	·	B
Tung Oil	B	B	C	C	A	·	·	·
Turpentine	B	B	C	C	A	C	·	A
Urea	B	A	B	A	A	B	·	B
Water & Brine	A	A	A	A	A	B	·	·
Zinc Chloride	A	A	B	A	A	A	A	B
Zinc Salts	A	A	A	A	·	·	·	·

NOTE: FKM tested to ANSI/NSF 61 with water only.

* Products tested and certified by IAPMO according to ANSI/NSF 61 for contact with Sodium Hypochlorite and Water only and ANSI/NSF 372.

ACCESSORIES

S30 ACCESSORIES

3 Connecting Nuts 1/4" & 3 Ferrules 1/4" or 6 mm *Europe*
or 3 Connecting Nuts & 2 Adapters 3/8"

1 Injection Fitting 25 psi (1.7 bar) max.
or 1 Duckbill Check Valve 100 psi (6.9 bar) max.

1 Weighted Suction Line Strainer 1/4", 3/8" or 6 mm *Europe*

20' Suction/Discharge Line 1/4" or 3/8", white or UV black
or 20' Suction/Discharge Line, white, 6 mm *Europe*

1 Additional Pump Tube

2 Additional Latches

1 Mounting Bracket

1 Quick Start Guide

S40, S50 ACCESSORIES

3 Connecting Nuts 3/8"

1 Ball Check Valve 3/8"

1 Weighted Suction Line Strainer 3/8"

20' Suction/Discharge Line 3/8", white or UV black

1 Additional Pump Tube

1 Mounting Bracket

1 Quick Start Guide

GENERAL INFORMATION

The S Series is an advanced peristaltic pump design with multiple programming features and performance indicators. The S Series offers practical and flexible functions for municipal, wastewater and industrial applications.

PUMP FEATURES

- Brushless DC Motor with ball bearing support
- Switch mode power supply
- Microcontroller
- Blue OLED Display
- Six button keypad on control panel
- Modbus RTU over RS-485 capability

OUTPUT

- Up to 315.0 gpd @ 25 psi max.
- Up to 125.0 gpd @ 100 psi max.

CONTROL PANEL



NAVIGATION BUTTONS

Button	General Function	Operating Mode Function
UP	<ul style="list-style-type: none"> • Moves up in a menu • Toggles between menu options • Increases a value 	Increases the speed percent in the Manual mode
DOWN	<ul style="list-style-type: none"> • Moves down in a menu • Toggles between options • Decreases a value 	Decreases the speed percent in the Manual mode
PRIME	N/A	Runs pump at 100% speed while button is pressed
ON/OFF	N/A	Turns pump control ON or OFF WARNING: DOES NOT REMOVE POWER
BACK	Moves one step back in a menu when permitted	Cycles the display to show different units of output
ENTER	Sets a value	Press and hold for 2 seconds to go to the Main Menu

SETUP

The very first time the pump is turned on, the display will show the Firmware Version followed by the **Main Menu** screen.

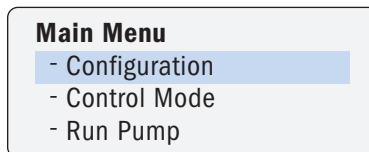
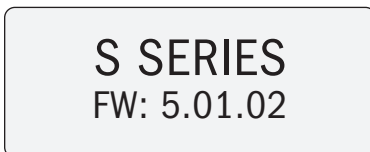

The display will indicate the pump's software version.

If the pump was previously programmed, the display will return to the mode it was in when it was turned off or if power was lost.

GENERAL INFORMATION continued

HOW TO GET STARTED SUMMARY

1 Calibrate Pump Flow Rate Output (mandatory)

From the Configuration menu, select GPD/LPD Calibration, and enter your pump's ACTUAL maximum flow rate output. Refer to illustration below.

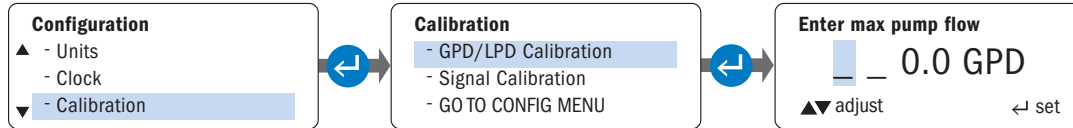

IMPORTANT!

The pump's ACTUAL maximum flow rate entry:

- Affects flow rate output displayed on the screen during operation in all modes.
- Contributes to overall calculation of flow rate output in the PPM modes.

2 Program Applicable Pump Parameters

In Configuration menu, program applicable pump parameters, refer to chart below.

Pump Parameters	Description	Control Mode
Display Brightness	Optimal setting is < 50% for extended periods.	All
Units	Default is Gallons; enter Liters, if preferred.	All
Clock	24-hr format. Enter current time of day and day of the week.	All
Leak Detect	Calibrate sensitivity to distinguish between water & your chemical.	All
Tube Timer	Enter number of hours you want pump to run before display shows TUBE CHANGE.	All
Password	Program a password to prevent unauthorized changes to pump settings.	All
Output Relays	Three individual relays available; rated for 24VDC @ 50mA max. Program communication for: · S Series to back-up S Series · S Series to another device	All
Signal Calibration	If factory settings are not sufficient, calibrate the pump using a process meter or powered transmitter.	4-20mA, 0-10VDC
Reset Totalizer	Option to reset the total tallied amount of water treated.	Pulse, Hall Effect, PPM
Modbus Setup	Modbus RTU over RS-485 capability; pump firmware 3.02.02 or higher	Manual, 4-20mA, 0-10VDC, Pulse

3 Select Mode of Operation

In Control Modes menu, select your mode of operation.

4 Program the Options

In your selected control mode, program the options relevant to your application.

5 Run the Pump

GENERAL INFORMATION continued

PUMP STATUS INDICATORS

INDICATORS ACTIVATED BY PUMP STATUS

Pump Status	Pump Status Indicators		Modes of Operation
	Display Alarm on control panel	Three Output Relays to pump, system or device	
Tube Change	✓	✓	All Modes of Operation
Tube Leak	✓	✓	
Standby	✓	✓	
Drive Fault	✓	✓	
Off	✓	✓	
Run	-----	✓	
Mode Change	-----	✓	
Transfer**	-----	✓	
Repeat Pulse	-----	✓	Manual, 4-20mA*, 0-10VDC*, Pulse, 7 Day Timer, Cycle Timer, PPM Feed: Flow switch
High Signal	✓	✓	4-20mA* or 0-10VDC*
Low Signal	✓	✓	4-20mA* or 0-10VDC*
High Flow	✓	✓	Hall Effect or PPM Feed: Hall Effect
Low Flow	✓	✓	Hall Effect
Signal Overrun	✓	✓	Pulse

* Scalable, invertible

** Transfer operation from a primary pump to a backup pump via a relay.

REMOTE COMMUNICATION CAPABILITY WITH MODBUS RTU over RS-485

Requirements

- S Series Pump with firmware version 3.02.02 or higher
- Applicable modes of operation: Manual, 4-20mA, 0-10VDC, or Pulse
- Stenner Modbus manual
- Modbus RS-485 communication cable & 1 three terminal, liquid tight junction; purchased separately, part number MOD100

CONFIGURATION MENU





The configuration of the pump parameters should be completed during the initial setup.

DISPLAY BRIGHTNESS

Operator can adjust the brightness level of the pump display from 0% to 100%. There is some visibility at the minimum setting.

NOTE: For best performance and longevity, the display brightness should not be set higher than 50% for extended periods.

NAVIGATION

 Moves up in a menu, toggles between options, or increase a value Holding the ▲ or ▼ button causes the numbers to change rapidly.	 Moves down in a menu, toggles between options, or decreases a value	 Moves one step back in a menu, when permitted	 Sets a value in a menu
--	--	--	---

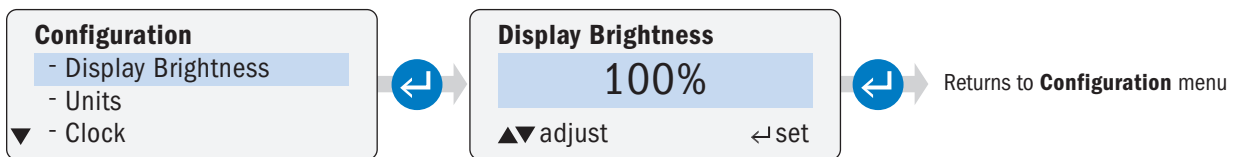





CONFIGURATION MENU continued

UNITS

Operator must set the unit of measure to Gallons or Liters. The selection appears in the pump display during **Control Mode** programming.

NAVIGATION

-  Moves up in a menu, toggles between options, or increase a value
Holding the ▲ or ▼ button causes the numbers to change rapidly.
-  Moves down in a menu, toggles between options, or decreases a value
-  Moves one step back in a menu, when permitted
-  Sets a value in a menu

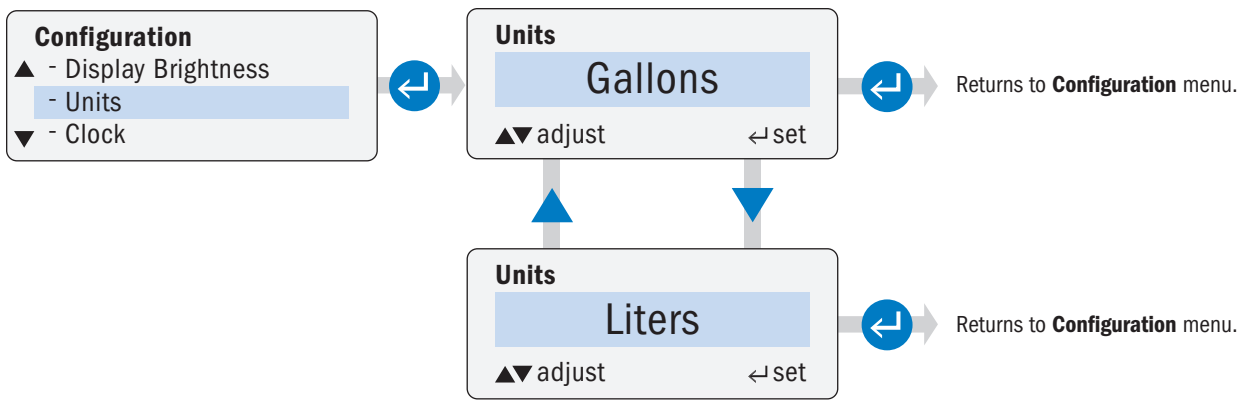





CONFIGURATION MENU continued

CLOCK

Operator can set the current day of the week and the time of day. The clock is in 24-hour format.

NAVIGATION

-  Moves up in a menu, toggles between options, or increase a value
Holding the ▲ or ▼ button causes the numbers to change rapidly.
-  Moves down in a menu, toggles between options, or decreases a value
-  Moves one step back in a menu, when permitted
-  Sets a value in a menu

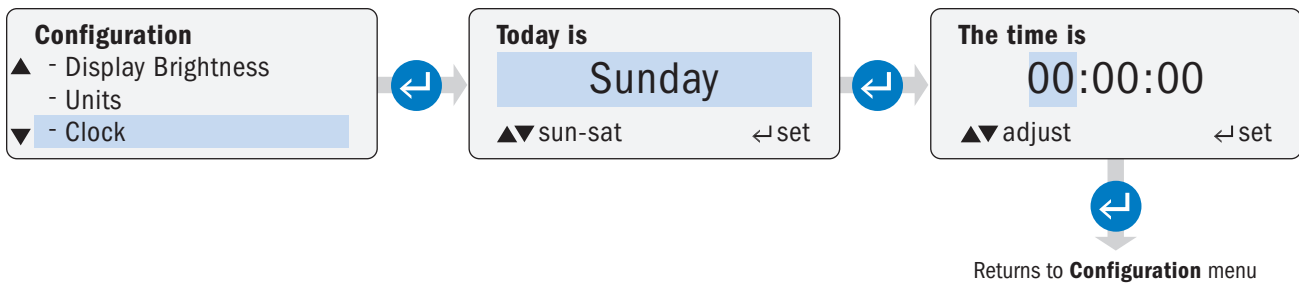

CONFIGURATION MENU continued

CALIBRATION page 1 of 2

Operator must set the pump's maximum flow rate output. The units displayed in the **Calibration** submenu are controlled by the units selected in the **Units** submenu.

IMPORTANT: The value entered (in **Calibration**) for the pump's maximum output is used to calculate the pump's required output for the operating mode in **Run Pump**. The value is also used to calculate the pump's required run speed in the **PPM Feed** submenu in **Control Mode**. For the most accurate dosing possible, determine the actual pump output. Conduct a drawdown from a graduated calibration column against the discharge run and pressure, equivalent to the intended installation.

NAVIGATION

- ▲ Moves up in a menu, toggles between options, or increase a value
Holding the ▲ or ▼ button causes the numbers to change rapidly.
- ▼ Moves down in a menu, toggles between options, or decreases a value
- ↶ Moves one step back in a menu, when permitted
- ↵ Sets a value in a menu

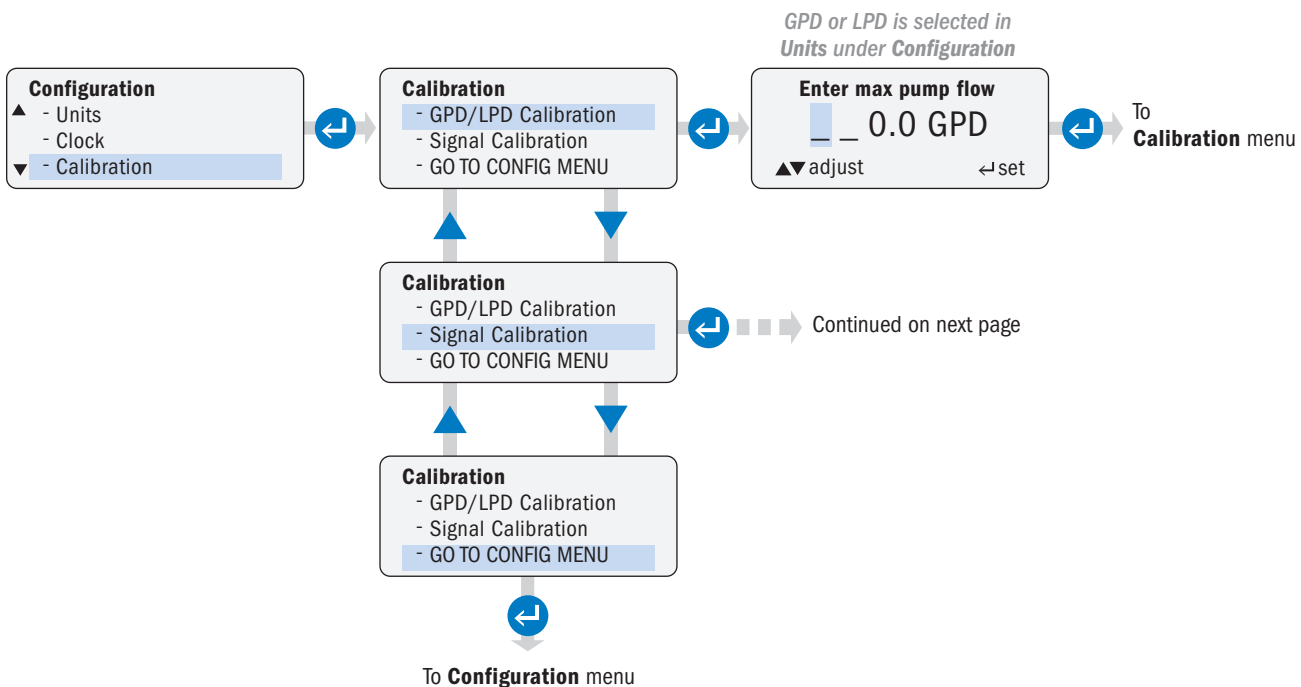

CONFIGURATION MENU continued

CALIBRATION page 2 of 2

Operator can calibrate analog signal inputs and outputs.

⚠ CAUTION 4-20mA and 0-10VDC input signals are pre-calibrated at the factory. Only change the input calibration if the factory settings are not sufficient.

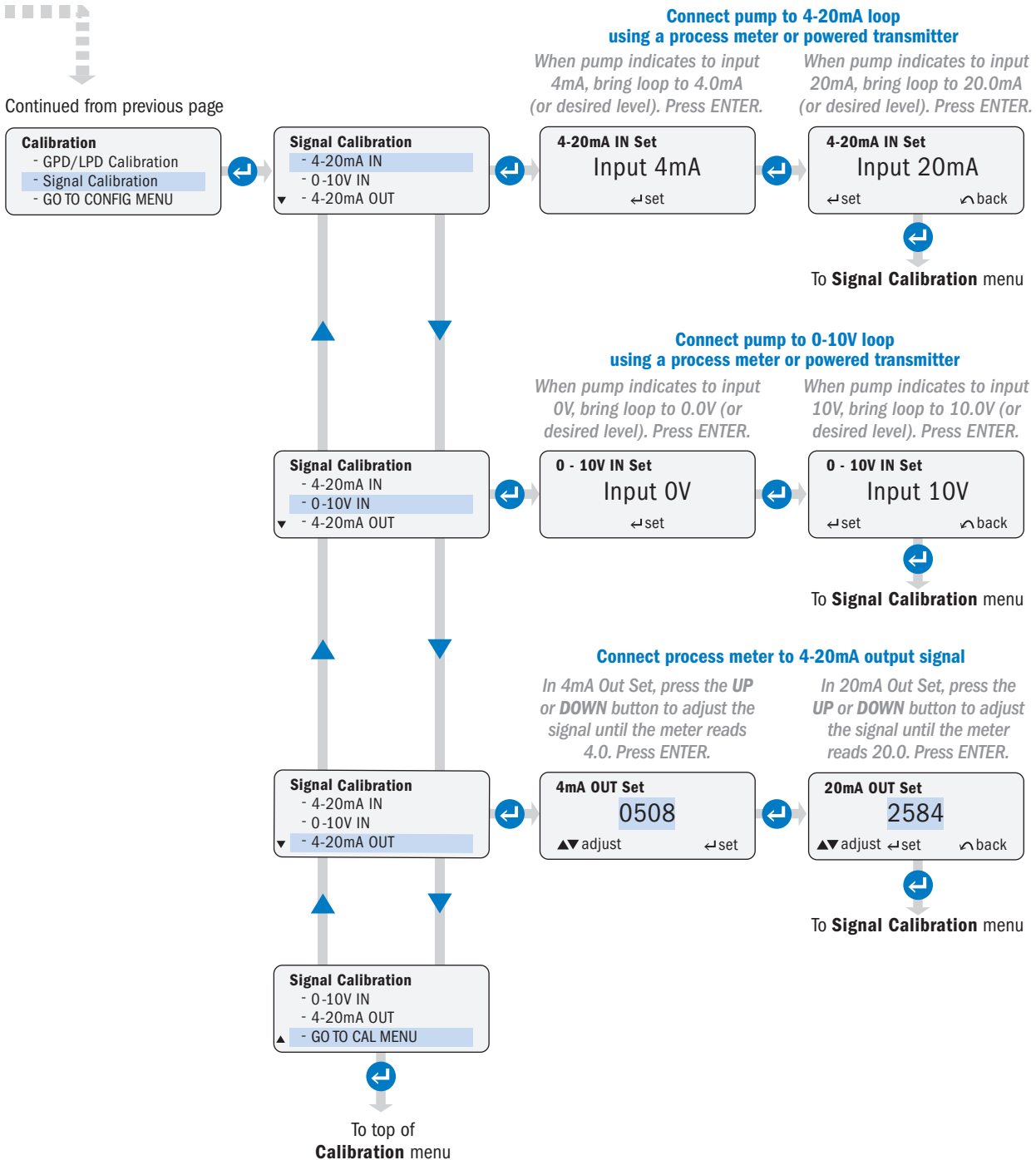





CONFIGURATION MENU continued

PASSWORD

Operator can set a password to prevent unauthorized changes to the pump settings.

- The password function is disabled by default.
- Password characters can be 0-9 or A-Z or a combination of both.
- After a password is set it takes two minutes to save, then it will be required to enter the Main Menu.
- To disable a set password, update the password to four blank spaces and confirm.

NAVIGATION

 Moves up in a menu, toggles between options, or increase a value Holding the ▲ or ▼ button causes the numbers to change rapidly.	 Moves down in a menu, toggles between options, or decreases a value	 Moves one step back in a menu, when permitted	 Sets a value in a menu
--	--	--	---

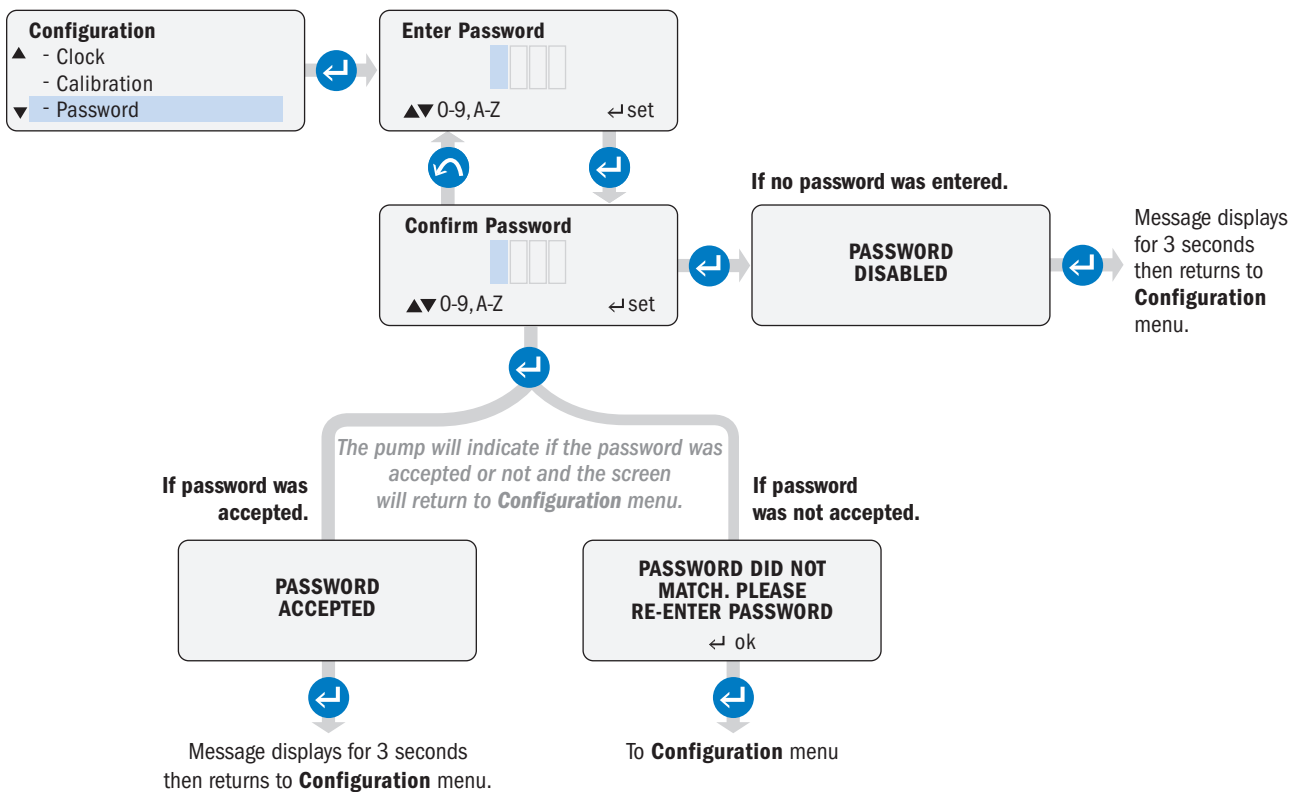

CONFIGURATION MENU continued

TUBE TIMER

The **Tube Timer** menu has three features.

- **CHECK** Go to Current Run Time to check the total hours the pump tube has been running.
- **SET** Go to Set Life Timer to set how many hours you want the tube to run before the tube change alarm is triggered.
- **RESET** After the tube is replaced, or after the tube change alarm displays or after a programmed relay is activated, go to Reset Tube Timer to reset the desired tube run hours.

NAVIGATION



Moves up in a menu, toggles between options, or increase a value



Moves down in a menu, toggles between options, or decreases a value



Moves one step back in a menu, when permitted



Sets a value in a menu

Holding the ▲ or ▼ button causes the numbers to change rapidly.

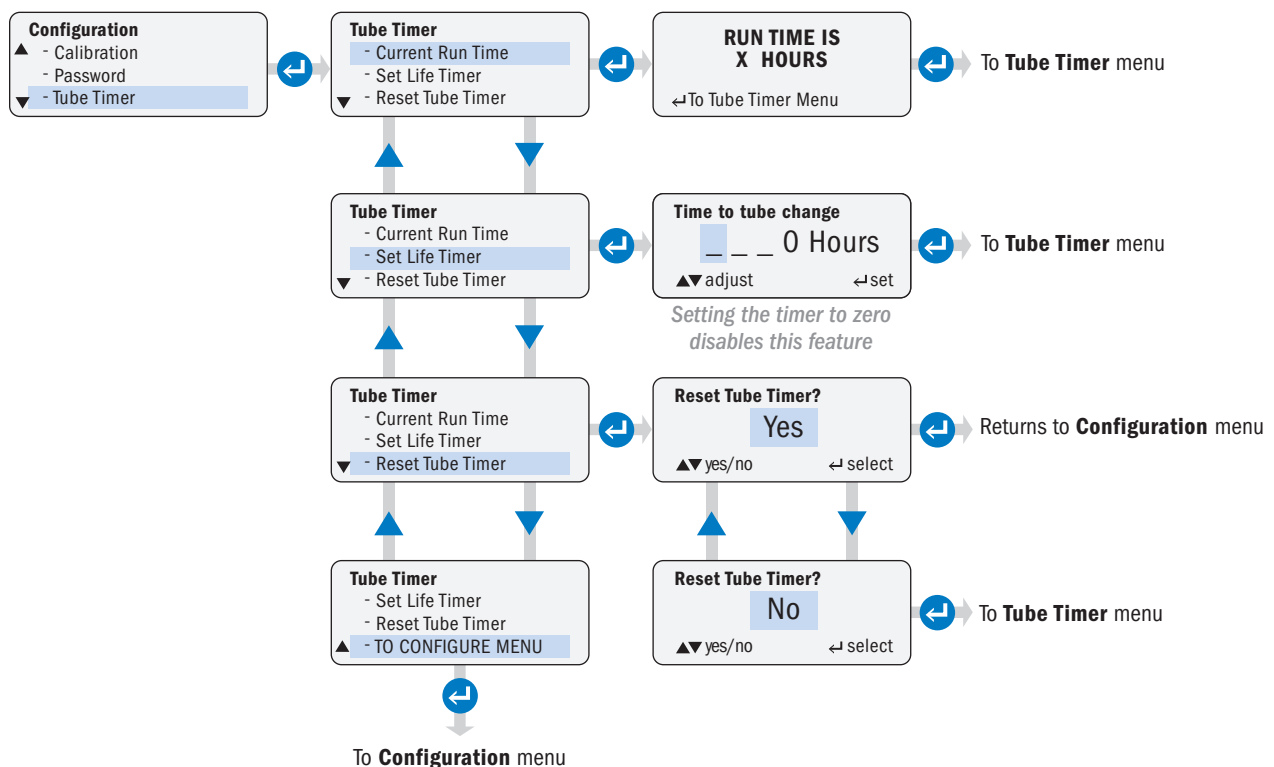





CONFIGURATION MENU continued

RESET TOTALIZER

Operator can reset the flow totalizer when using the **Pulse, Hall Effect, or PPM Feed** control modes.

NAVIGATION

-  Moves up in a menu, toggles between options, or increase a value
Holding the ▲ or ▼ button causes the numbers to change rapidly.
-  Moves down in a menu, toggles between options, or decreases a value
-  Moves one step back in a menu, when permitted
-  Sets a value in a menu

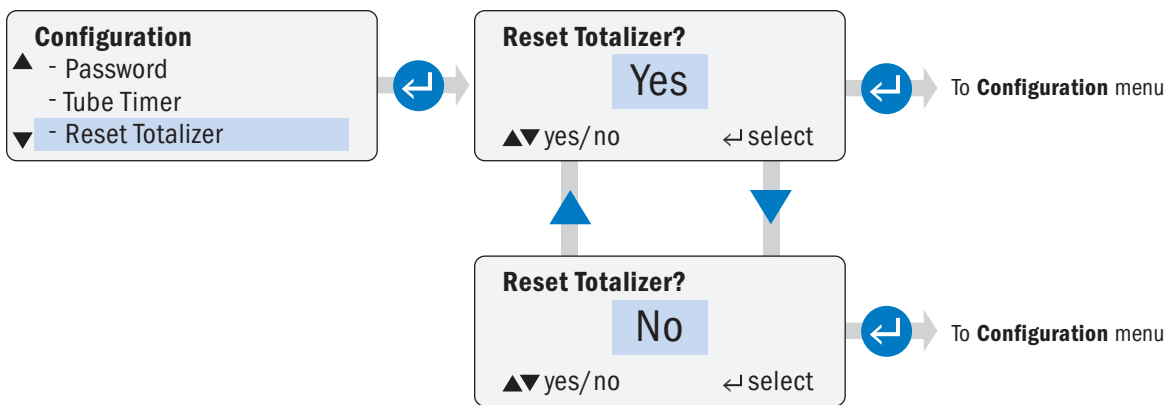

CONFIGURATION MENU continued

LEAK DETECT

The leak detecting components determine when solution is present in the pump head. When a leak is detected, the tube icon will always appear on the display.

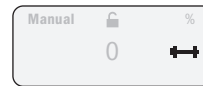

Program how the pump responds when a leak is detected:

1. Set the display alarm, TUBE LEAK, to appear on the screen.
2. Set the pump to stop or continue to run when TUBE LEAK appears.
3. To prevent false alarms, set a delay (in seconds) to delay activation of pump response after a leak is detected.

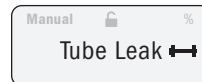

Leak detect is accomplished by sensing conductivity between two metal clips in the tube housing cover. The leak detect bracket and leak detect tube housing cover must be installed in order to use this option.

The alarm on leak detect is disabled by default. The delay for the alarm to activate is also set to zero by default.

Tip: The leak detect sensitivity is factory pre-set to distinguish between water and typical water treatment chemicals. Adjust the sensitivity according to the specific chemical utilized in the application. Adjust with the potentiometer located under the signal cover. Instruction for adjusting are located in *Connections Leak Detect* in this manual.

NAVIGATION

- ▲ Moves up in a menu, toggles between options, or increase a value
Holding the ▲ or ▼ button causes the numbers to change rapidly.
- ▼ Moves down in a menu, toggles between options, or decreases a value
- ↶ Moves one step back in a menu, when permitted
- ⏪ Sets a value in a menu

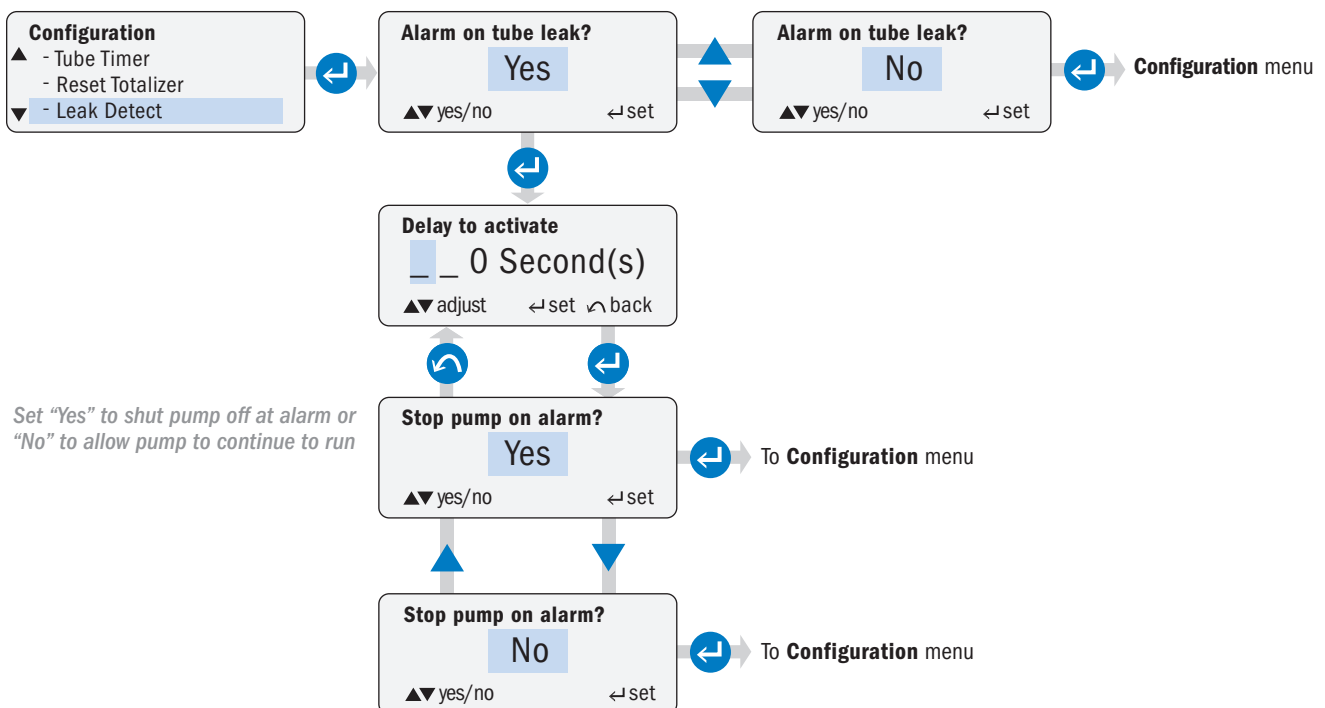

CONFIGURATION MENU continued

OUTPUT RELAYS page 1 of 5

Operator can configure up to three internal relays for output indication from the pump to a control system, another pump or miscellaneous receptacle.

- The relays can be programmed Normally Open (NO) or Normally Closed (NC) and are rated for 24VDC @ 50mA maximum.
- Each relay is individually programmed (in Configuration) for each alarm and must be “enabled” to function.

OUTPUT RELAYS IN ALL MODES OF OPERATION

Leak Detect: Activates relay if a leak is detected and if Leak Detect is programmed in Configuration.

Run: Automatically activates the relay when the pump is running.

Transfer: Activates the relay to transfer operation from the primary pump to a backup pump.

- Automatically activates when a drive fault or loss of power occurs.
- Activates when Leak Detect is programmed in Configuration with the "stop pump" option selected and when a leak occurs.

IMPORTANT!

- The primary pump's output relay must be wired to the backup pump's Standby input connection.
- The backup pump must be programmed in the same mode of operation as the primary pump.
- The backup pump must be powered by a circuit separate from the circuit powering the primary pump.
- The relay must be programmed as Normally Closed.

Tube Timer: Activates relay when the tube run time is reached. The tube run time must be programmed in Configuration.

Drive Fault: Automatically activates the relay if the pump shuts down due to a drive fault error.

Standby: Automatically activates the relay if a closed relay is wired into the Standby connection terminals causing the pump to go into Standby.

Off: Automatically activates the relay if the pump is turned OFF from the control panel.

Mode Change: Activates the relay if the pump's mode of operation is changed from the operator's selected mode of operation.

OUTPUT RELAYS IN SPECIFIC MODES OF OPERATION

Low Signal in 4-20mA or 0-10VDC

- Activates the relay if the input signal falls below the value programmed in the control mode.

High Signal in 4-20mA or 0-10VDC

- Activates the relay if the input signal rises above the value programmed in the control mode.

Low Flow in Hall Effect

- Activates the relay if the process flow falls below the gpm or lpm programmed in the control mode.

High Flow in Hall Effect or PPM Feed-Variable

- Activates the relay if the process flow rises above the gpm or lpm programmed in the control mode.

Signal Overrun in Pulse

- Activates the relay if the pump receives an input signal leading to incorrect dosing.

Repeat Pulse – Manual, 4-20mA, 0-10VDC, Pulse, 7 Day Timer, PPM Feed-Constant or Cycle Timer

- Automatically activates the relay when the pump receives the dry contact input signal to repeat this signal to another pump or device.

CONFIGURATION MENU continued

OUTPUT RELAYS page 2 of 5

INDICATORS ACTIVATED BY PUMP STATUS

Pump Status	Pump Status Indicators		Modes of Operation
	Display Alarm on control panel	Three Output Relays to pump, system or device	
Tube Change	✓	✓	All Modes of Operation
Tube Leak	✓	✓	
Standby	✓	✓	
Drive Fault	✓	✓	
Off	✓	✓	
Run	-----	✓	
Mode Change	-----	✓	
Transfer**	-----	✓	
Repeat Pulse	-----	✓	Manual, 4-20mA*, 0-10VDC*, Pulse, 7 Day Timer, Cycle Timer, PPM Feed: Flow switch
High Signal	✓	✓	4-20mA* or 0-10VDC*
Low Signal	✓	✓	4-20mA* or 0-10VDC*
High Flow	✓	✓	Hall Effect or PPM Feed: Hall Effect
Low Flow	✓	✓	Hall Effect
Signal Overrun	✓	✓	Pulse

* Scalable, invertible

** Transfer operation from a primary pump to a backup pump via a relay.

CONFIGURATION MENU continued

OUTPUT RELAYS page 3 of 5

- Program the individual output relays (1, 2, and 3) as desired. Example illustrates selecting Relay #1
- Enable or disable the relays as desired.

NAVIGATION

▲ Moves up in a menu, toggles between options, or increase a value
 ▼ Moves down in a menu, toggles between options, or decreases a value
 Holding the ▲ or ▼ button causes the numbers to change rapidly.

↶ Moves one step back in a menu, when permitted

⏪ Sets a value in a menu

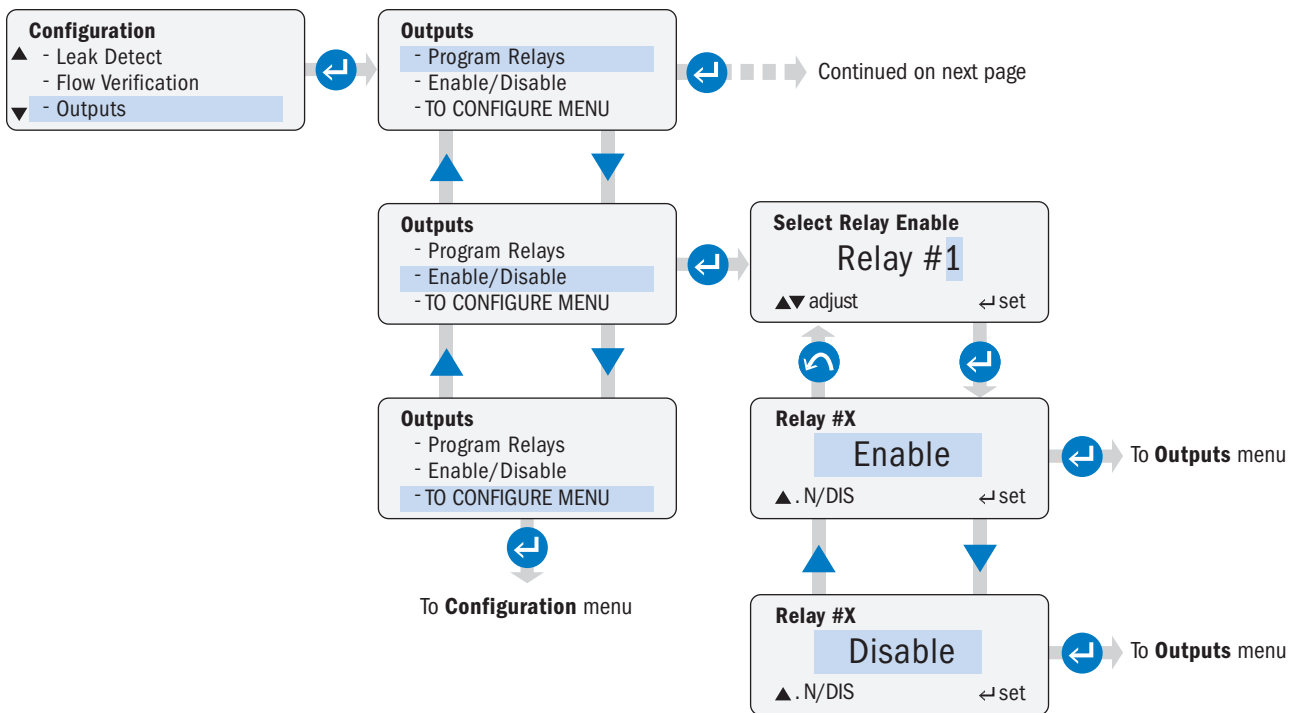

CONFIGURATION MENU continued

OUTPUT RELAYS page 4 of 5

Continued from previous page

Outputs

- Program Relays
- Enable/Disable
- To Configure menu

Select Relay
Relay #1
▲▼ adjust ↵ set

Relay #1
Normally Open
▲ n.o./n.c. ↵ set

Relay #1
Normally Closed
▲ n.o./n.c. ↵ set

Example shows programming Relay #1.

Relay #1 Leak Detect Off
▲▼ on/off ↵ set

Relay #1 Flow Detect Off
▲▼ on/off ↵ set

Relay #1 Repeat Pulse Off
▲▼ on/off ↵ set

Relay #1 Run Off
▲▼ on/off ↵ set

Relay #1 Transfer Off
▲▼ on/off ↵ set

Relay #1 Tube Timer Off
▲▼ on/off ↵ set

Relay #1 Low Signal Off
▲▼ on/off ↵ set

Relay #1 High Signal Off
▲▼ on/off ↵ set

Relay #1 Low Flow Off
▲▼ on/off ↵ set

Relay #1 High Flow Off
▲▼ on/off ↵ set

Relay #1 Drive Fault Off
▲▼ on/off ↵ set

Relay #1 Overrun Off
▲▼ on/off ↵ set

Relay #1 Standby Off
▲▼ on/off ↵ set

Relay #1 Off Off
▲▼ on/off ↵ set

Relay #1 Mode Change Off
▲▼ on/off ↵ set

Off
To **Outputs** menu

Any Control Mode

Manual 4-20mA 0-10VDC Pulse 7-Day PPM-Constant Cycle Timer

Any Control Mode

Any Control Mode

Hall Effect

Hall Effect or PPM Feed-Variable

Any Control Mode

Pulse

Any Control Mode

On Continued on next page

Select "ON" to enable the relay to activate for the specific condition.

Select "OFF" to deactivate the relay for the specific condition. "OFF" is the default mode.

NOTE: All condition options are shown. Not all conditions are applicable to all control modes.

CONFIGURATION MENU continued

OUTPUT RELAYS page 5 of 5

Continued from previous page

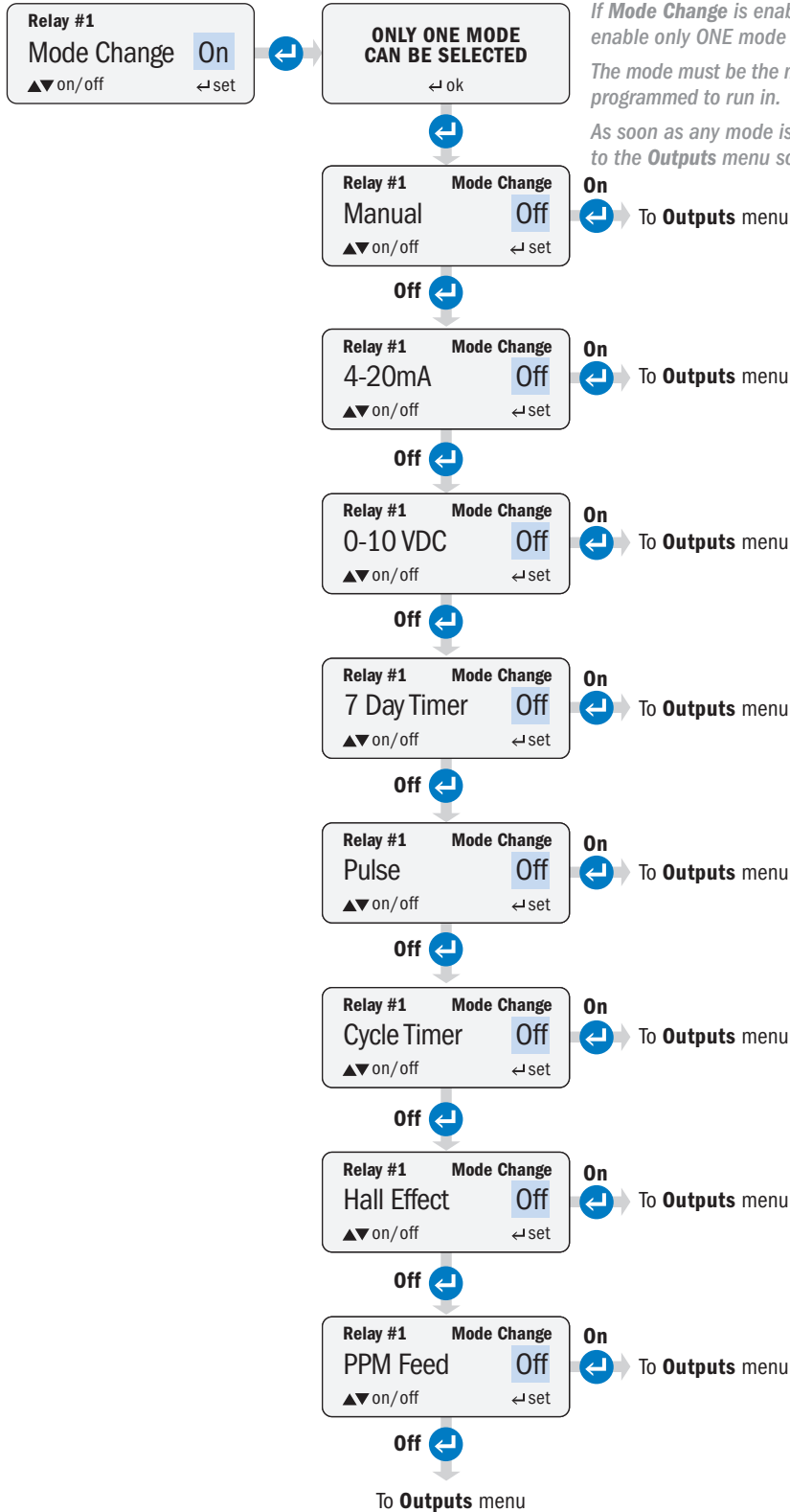

If **Mode Change** is enabled, then select "ON" to enable only ONE mode operation.

The mode must be the mode the pump will be programmed to run in.





As soon as any mode is selected, the display will go to the **Outputs** menu so the relays can be enabled.

CONFIGURATION MENU continued

FIRMWARE VERSION

Operator can check the pump's firmware version.

NAVIGATION

 Moves up in a menu, toggles between options, or increase a value Holding the ▲ or ▼ button causes the numbers to change rapidly.	 Moves down in a menu, toggles between options, or decreases a value	 Moves one step back in a menu, when permitted	 Sets a value in a menu
--	--	--	---

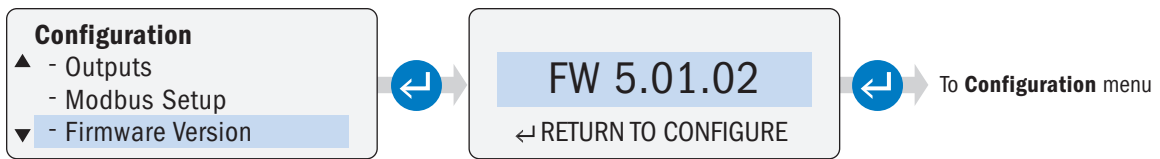

CONFIGURATION MENU continued

RESET PUMP

Operator can reset the pump and return the pump to factory default settings.

NOTE: When resetting a pump with firmware version 2.01.04 or higher, the 4-20mA input signal calibration will be restored to factory default settings.

NAVIGATION

- Moves up in a menu, toggles between options, or increase a value
Holding the ▲ or ▼ button causes the numbers to change rapidly.
- Moves down in a menu, toggles between options, or decreases a value
- Moves one step back in a menu, when permitted
- Sets a value in a menu

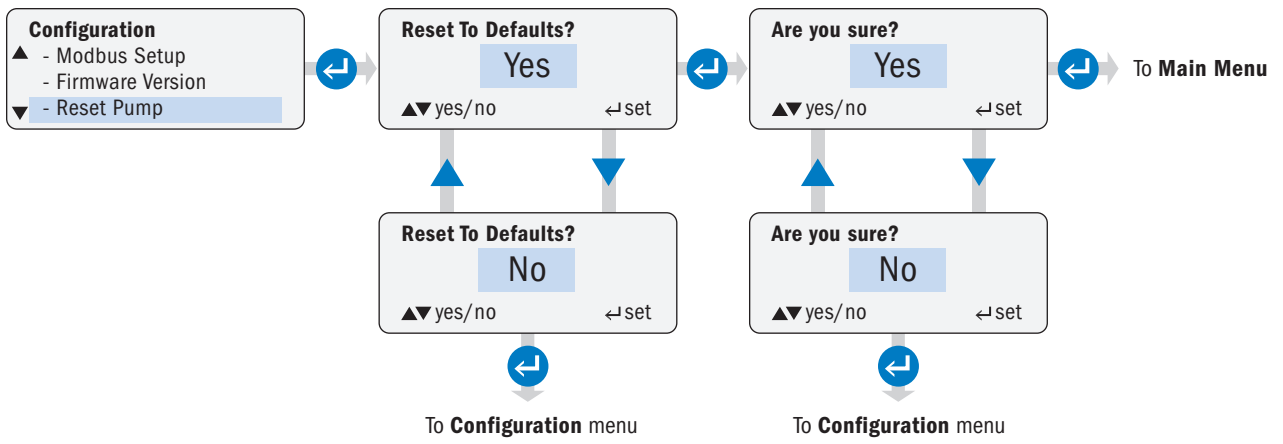

CONFIGURATION MENU continued

GO TO MAIN MENU

Operator can return to the **Main Menu**.

NAVIGATION



Moves up in a menu, toggles between options, or increase a value

Holding the ▲ or ▼ button causes the numbers to change rapidly.



Moves down in a menu, toggles between options, or decreases a value



Moves one step back in a menu, when permitted



Sets a value in a menu

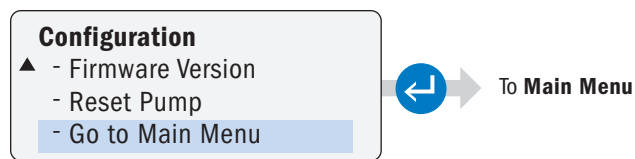

CONTROL MODES MENU

Select the mode of operation and set the parameters.

MANUAL

Operator can control the pump speed manually. Speed can be adjusted from 0 to 100% in one percent increments.

NAVIGATION



Moves up in a menu, toggles between options, or increase a value



Moves down in a menu, toggles between options, or decreases a value



Moves one step back in a menu, when permitted



Sets a value in a menu

Holding the ▲ or ▼ button causes the numbers to change rapidly.

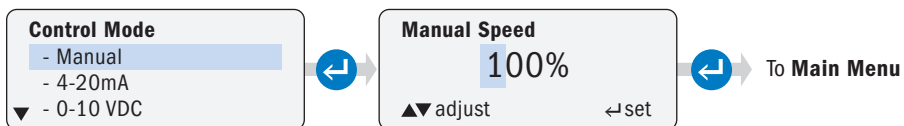

CONTROL MODES MENU continued

PPM FEED page 1 of 4

Operator can configure the pump to automatically dose a specific ppm of solution into the process flow.

PPM feed has two options: **Constant Flow, Flow Switch** and **Variable Flow, Hall Effect**.

Constant Flow, Flow Switch: The Constant Flow, Flow Switch option is used with process systems with a constant flow. The pump accepts a dry contact or an open collector signal to trigger the pump.

Program the pump with the:

- Process flow rate (GPM or LPM selected in the **Units** submenu of **Configuration**)
- Chemical concentration %
- Desired PPM dosing rate of the chemical

The pump uses the following equations to calculate the required speed:

- GPD

$$\text{Pump Output Required (GPD)} = \frac{\text{Process GPM} \times \text{Feed Rate PPM} \times 1440}{\text{Chemical Concentration \%} \times 10,000 \times \text{Specific Gravity}}$$

$$\text{Pump Speed (\%)} = \frac{\text{Pump Output Required (GPD)} \times 100}{\text{Max Pump Flow (GPD)}}$$

- LPD

$$\text{Pump Output Required (LPD)} = \frac{\text{Process LPM} \times \text{Feed Rate PPM} \times 1440}{\text{Chemical Concentration \%} \times 10,000 \times \text{Specific Gravity}}$$

$$\text{Pump Speed (\%)} = \frac{\text{Pump Output Required (LPD)} \times 100}{\text{Max Pump Flow (LPD)}}$$

- When the pump receives an input signal, it runs at the speed calculated to dose the PPM level programmed.

CONTROL MODES MENU continued

PPM FEED – VARIABLE FLOW, HALL EFFECT page 2 of 4

The Variable Flow, Hall Effect option is used with process systems with a variable flow. The pump accepts a hall effect input from a flow meter (typically, a paddlewheel or turbine type meter).

Program the pump with the:

- Meter K factor
- Process minimum and maximum flow rate (GPM or LPM selected in the **Units** submenu of **Configuration**)
- Chemical concentration %
- Specific gravity of the chemical
- Desired PPM dosing rate of the chemical

The pump uses the following equations to calculate the required speed:

- GPD

$$\text{Pump Output Required (GPD)} = \frac{\text{Process GPM} \times \text{Feed Rate PPM} \times 1440}{\text{Chemical Concentration \%} \times 10,000 \times \text{Specific Gravity}}$$

$$\text{Pump Speed (\%)} = \frac{\text{Pump Output Required (GPD)} \times 100}{\text{Max Pump Flow (GPD)}}$$

- LPD

$$\text{Pump Output Required (LPD)} = \frac{\text{Process LPM} \times \text{Feed Rate PPM} \times 1440}{\text{Chemical Concentration \%} \times 10,000 \times \text{Specific Gravity}}$$

$$\text{Pump Speed (\%)} = \frac{\text{Pump Output Required (LPD)} \times 100}{\text{Max Pump Flow (LPD)}}$$

CONTROL MODES MENU continued

PPM FEED – VARIABLE FLOW, HALL EFFECT page 3 of 4

⚠ CAUTION A process flow that exceeds the maximum programmed flow rate will lead to incorrect dosing. It is recommended to the high flow alarm. Alarms activate when settings are exceeded.

NAVIGATION



Moves up in a menu, toggles between options, or increase a value

Holding the ▲ or ▼ button causes the numbers to change rapidly.



Moves down in a menu, toggles between options, or decreases a value



Moves one step back in a menu, when permitted



Sets a value in a menu

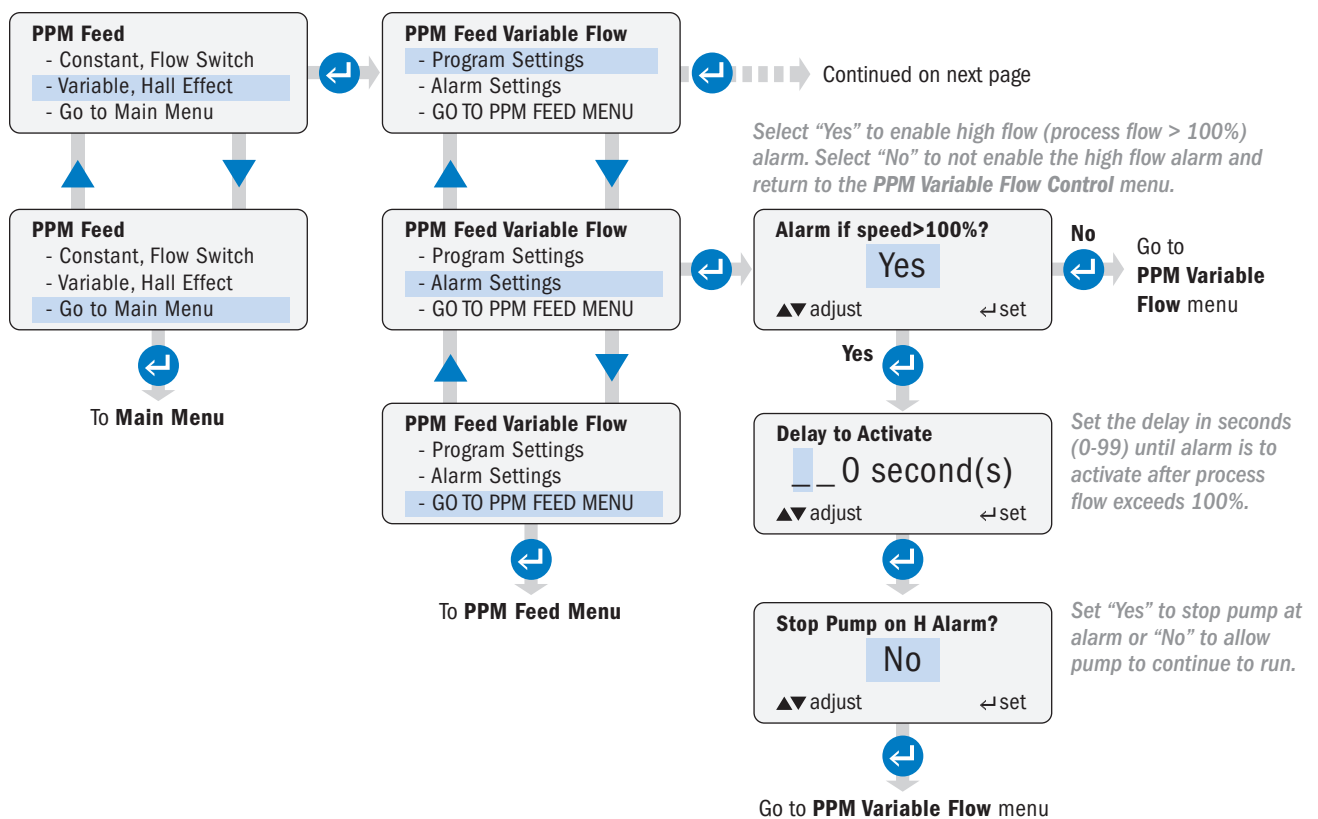





CONTROL MODES MENU continued

PPM FEED – VARIABLE FLOW, HALL EFFECT page 4 of 4

- The pump provides +12VDC to the meter.
- The meter's K factor (pulses per unit of volume) is specified by the meter manufacturer.
- Typically, the meter manufacturer specifies a minimum flow rate for the meter. The pump minimum process flow rate setting should not be set below the meter manufacturer's recommendation.

NAVIGATION

 Moves up in a menu, toggles between options, or increase a value Holding the ▲ or ▼ button causes the numbers to change rapidly.	 Moves down in a menu, toggles between options, or decreases a value	 Moves one step back in a menu, when permitted	 Sets a value in a menu
--	--	--	---

Continued from previous page

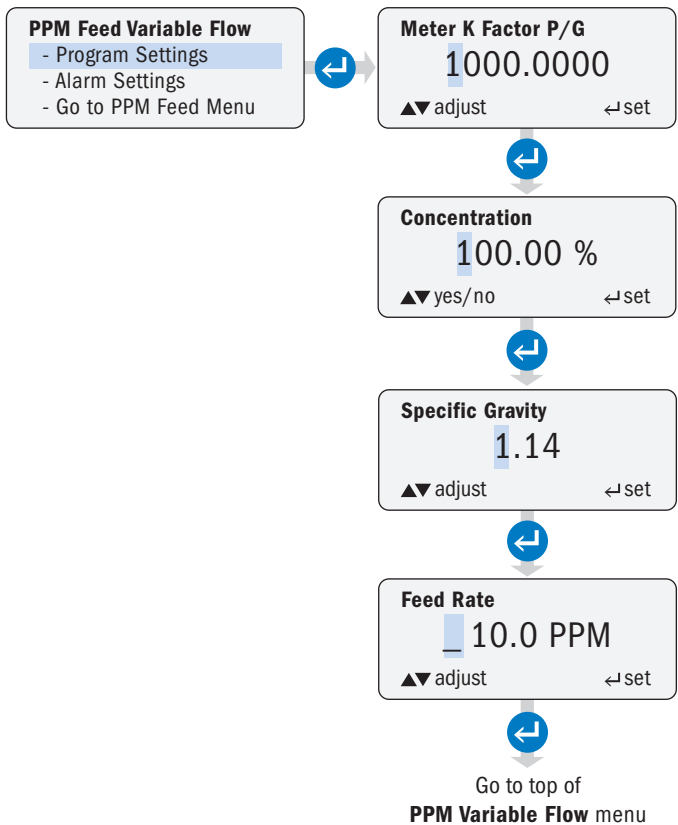

CONTROL MODES MENU continued

GO TO MAIN MENU

Operator can return to **Main Menu**.

NAVIGATION



Moves up in a menu, toggles between options, or increase a value

Holding the ▲ or ▼ button causes the numbers to change rapidly.



Moves down in a menu, toggles between options, or decreases a value



Moves one step back in a menu, when permitted



Sets a value in a menu

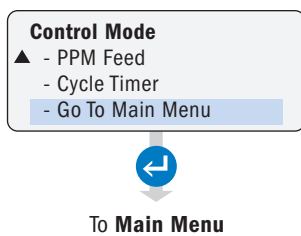







OPERATING DISPLAY

After selecting “**Run Pump**” in the **Main Menu** and pressing ENTER, the pump will go into operating mode and start running based on the programmed settings.

- If a password is set, the pump controls will lock out after 60 seconds if there is no keypad activity.
- To unlock the pump, press ENTER for 2 seconds. The pump will display a prompt to enter a password.

If using Modbus, refer to the Modbus manual for Run Pump.

In operating mode, the following functions are available when the pump is unlocked or no password is set:

Button	Operating Mode Function
 UP	Increases the speed percent in the Manual mode
 DOWN	Decreases the speed percent in the Manual mode
 PRIME	Runs pump at 100% speed while button is pressed
 ON/OFF	Turns pump control ON or OFF WARNING: DOES NOT REMOVE POWER
 BACK	Cycles the display to show different units of output
 ENTER	Press and hold for 2 seconds to go to the Main Menu

OPERATING DISPLAY continued

MANUAL

NAVIGATION IN OPERATING MODE



PRIME

Runs pump at 100% speed while button is pressed



ON/OFF

Turns pump control ON or OFF
WARNING: DOES NOT remove power.



BACK

Cycles the display through the units of output



ENTER

Press and hold for 2 seconds to go to the Main Menu

- When no password is set in Manual Mode, the speed can be adjusted from the operating display via the **UP** and **DOWN** buttons.
- If a password is set, the pump controls will lock out after 60 seconds if there is no keypad activity.
- To unlock the pump, press ENTER for 2 seconds. The pump will display a prompt to enter a password.

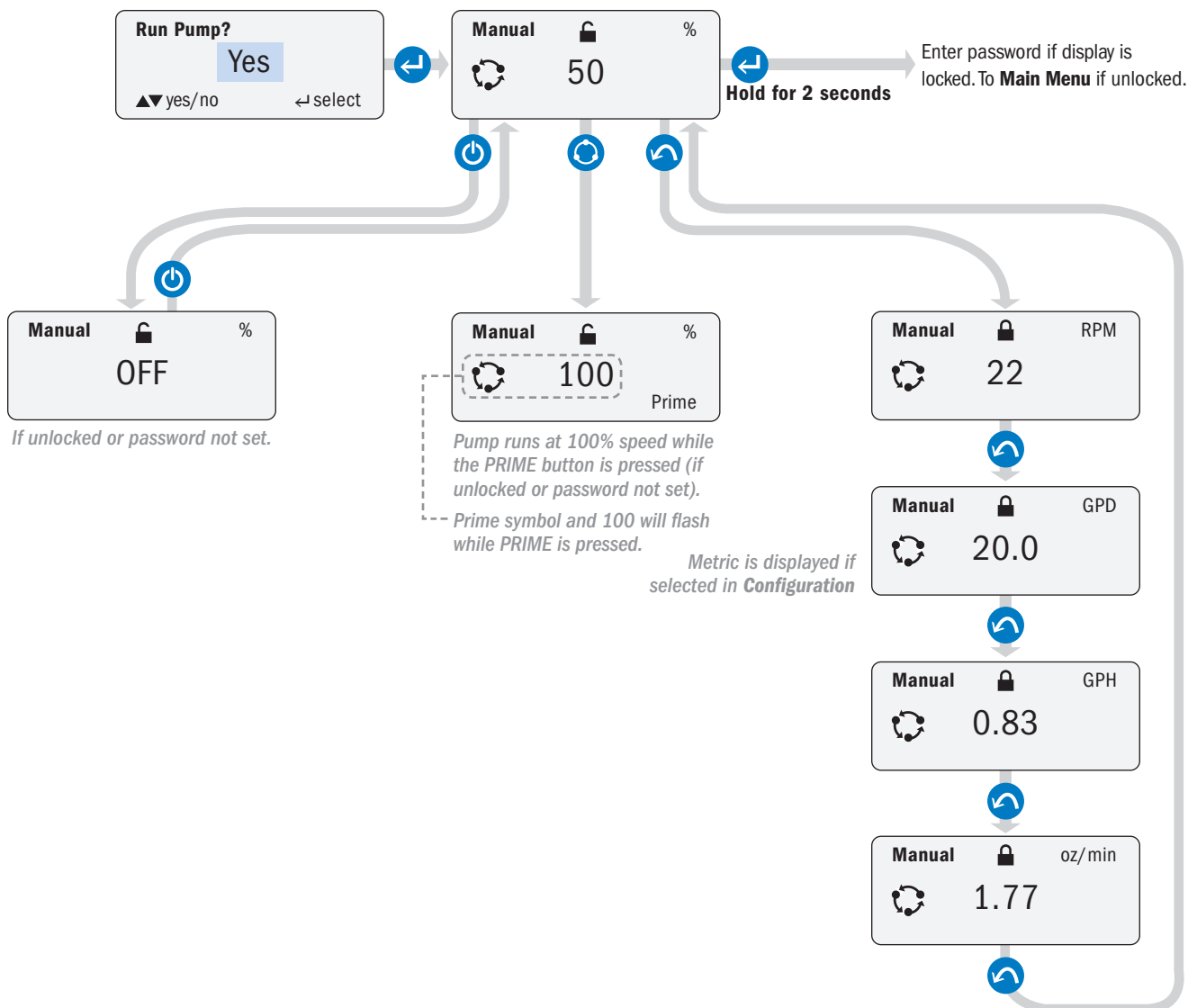

OPERATING DISPLAY continued

PPM FEED, VARIABLE FLOW

NAVIGATION IN HALL EFFECT MODE



PRIME

Runs pump at 100% speed while button is pressed



ON/OFF

Turns pump control ON or OFF
WARNING: DOES NOT remove power.



BACK

Cycles the display through the units of output, current process flow, and total process flow (gallons or liters, GPM or LPM).



ENTER

Press and hold for 2 seconds to go to the Main Menu

- If a password is set, the pump controls will lock out after 60 seconds if there is no keypad activity.
- To unlock the pump, press ENTER for 2 seconds. The pump will display a prompt to enter a password.

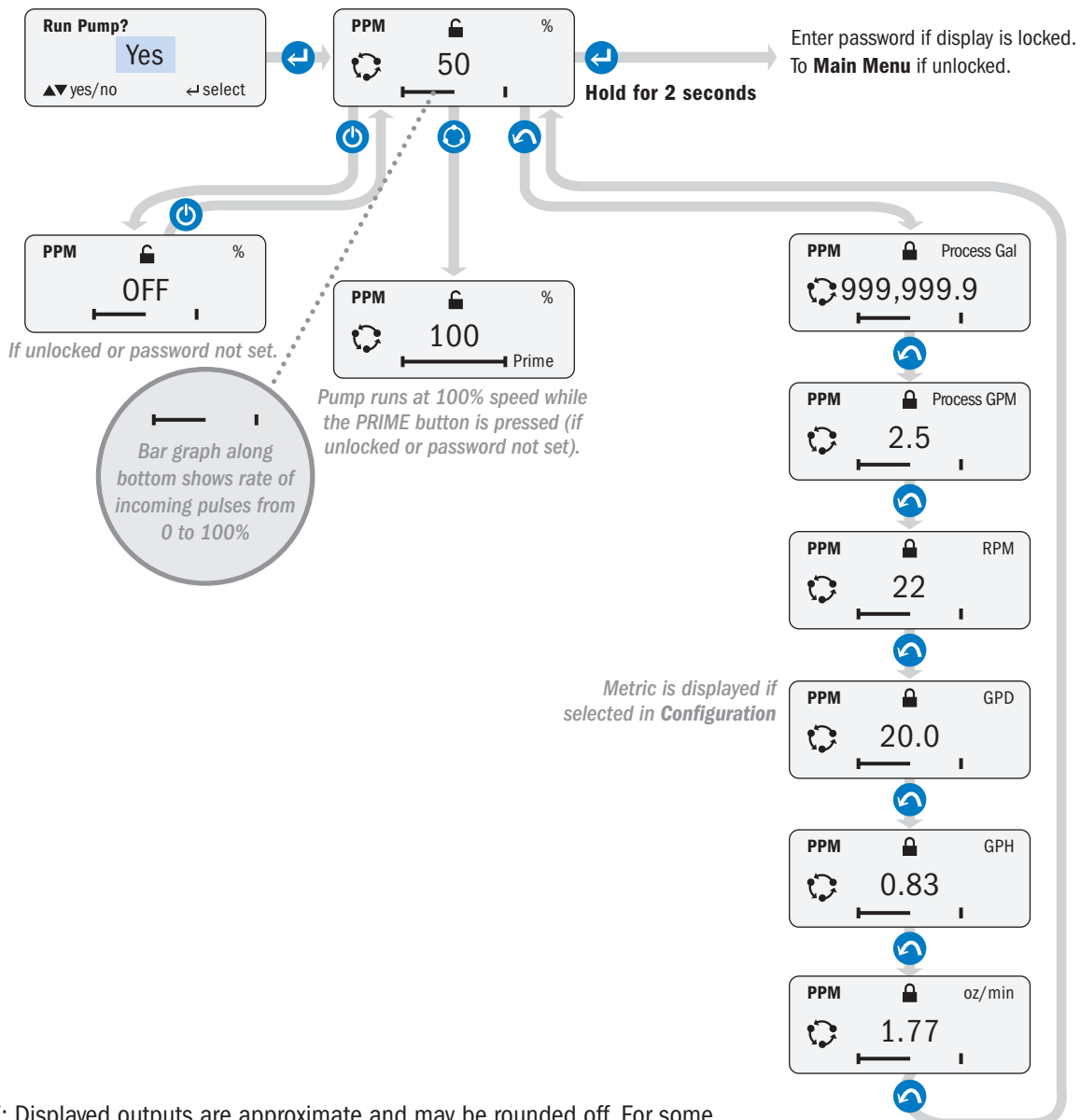

NOTE: Displayed outputs are approximate and may be rounded off. For some units of measure, flows close to zero may display zero.

OPERATING DISPLAY continued

ENTER PASSWORD

NAVIGATION IN OPERATING MODE



PRIME

Runs pump at 100% speed while button is pressed



ON/OFF

Turns pump control ON or OFF
WARNING: DOES NOT remove power.



BACK

Cycles the display through the units of output



ENTER

Press and hold for 2 seconds to go to the Main Menu

- If a password is set, the pump controls will lock out after 60 seconds if there is no keypad activity.
- To unlock the pump, press ENTER for 2 seconds. The pump will display a prompt to enter a password.

This example shows the **MANUAL** operating display. The password steps are the same from any operating display.

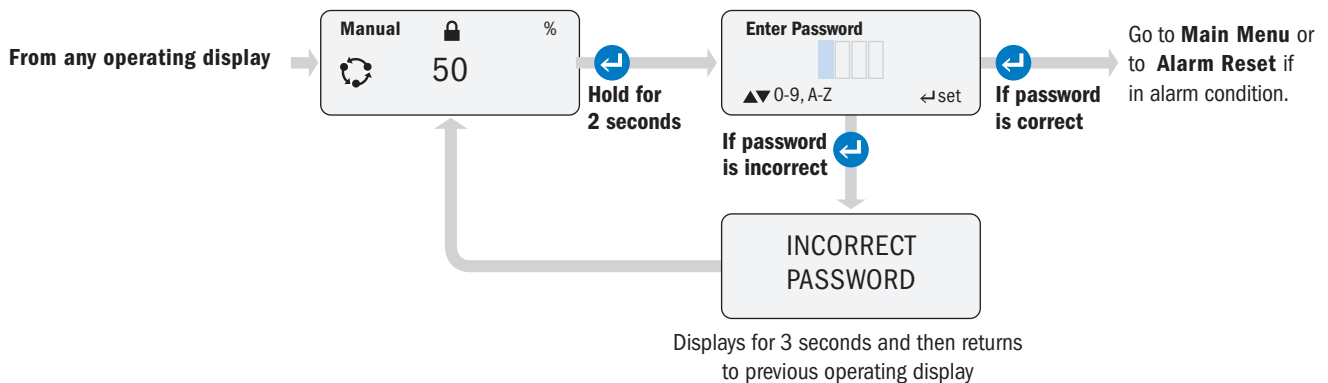

OPERATING DISPLAY continued

DISPLAY ALARMS

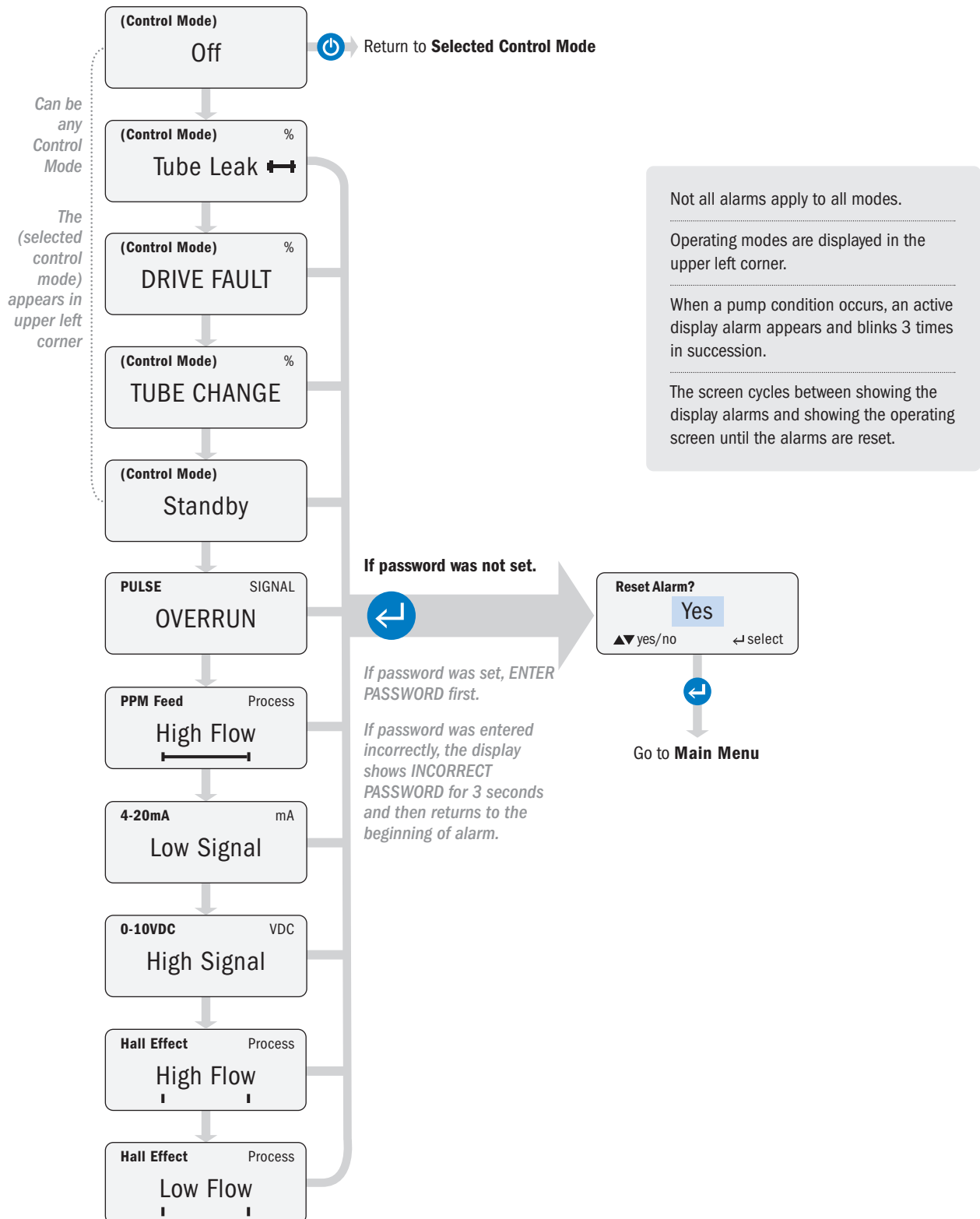

CONNECTIONS

INTERFACE CONNECTIONS

The input and output connection terminals are located at the rear of the pump. To access it, unplug the pump and remove the signal cover by taking out the Phillips head screws that secure it in place.

Prepare the signal cable by removing 3.5" of the outer jacket. Bare 1/4" on the ends of the signal wires. See cautionary note below on wire approval, shielding, size, etc.

Loosen the outer nuts on the liquid tight cord grips. Remove rubber plug from the cord grip.

Insert a sufficient length of signal cable through the cord grip to allow for wiring.

Make connections as required.

Adjust signal cable so that the outer jacket is flush with the inside of the cord grip. Tighten the cord grip nut flush with the cord grip body.

Replace signal cover, ensure the signal wires do not get pinched between the signal cover and pump body.

Replace the signal cover screws, use care to find existing threads and tighten until the signal cover is evenly and fully tightened flush with the housing

 **WARNING** Failure to properly tighten or secure the cord grip or signal cover may allow water to enter the pump enclosure, which can cause pump failure, property damage, or personal injury.

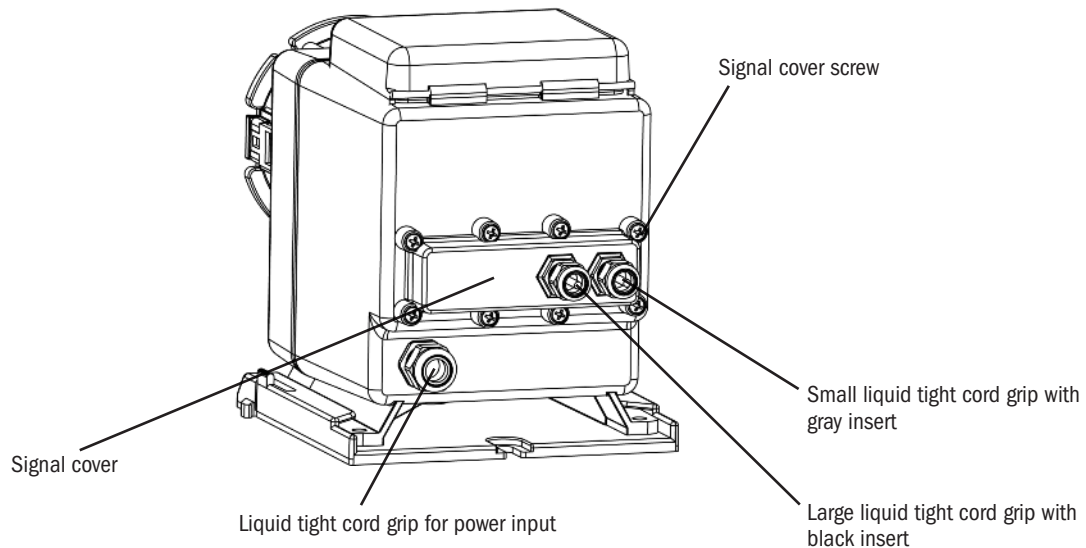

 **CAUTION** Signal cables must be UL, cUL AWM Style 2464 approved with conductors between 28 AWG and 18 AWG. Jacket diameter for small liquid tight must be 0.064" to 0.210". Jacket diameter for large liquid tight must be 0.114" to 0.250".

CONNECTIONS continued

REAR OF THE PUMP WITH SIGNAL COVER REMOVED

⚠ CAUTION If connecting a shielded signal cable to the pump signal cable, ensure that the shield wire is properly grounded on the controller (non-pump) side.

⚠ CAUTION DO NOT run signal wires in proximity to high voltage wires.

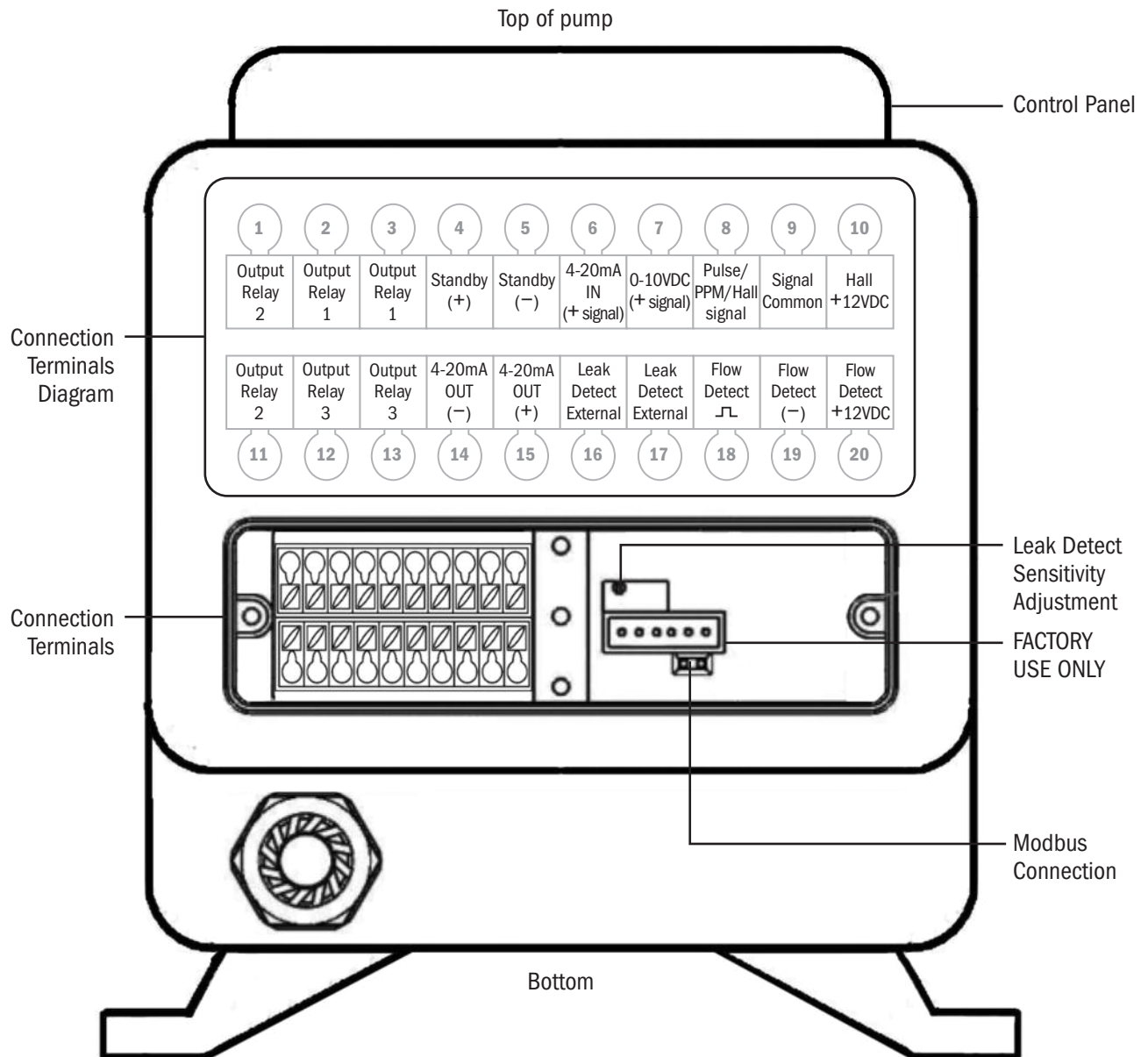

CONNECTIONS continued

HALL EFFECT OR PPM VARIABLE FEED

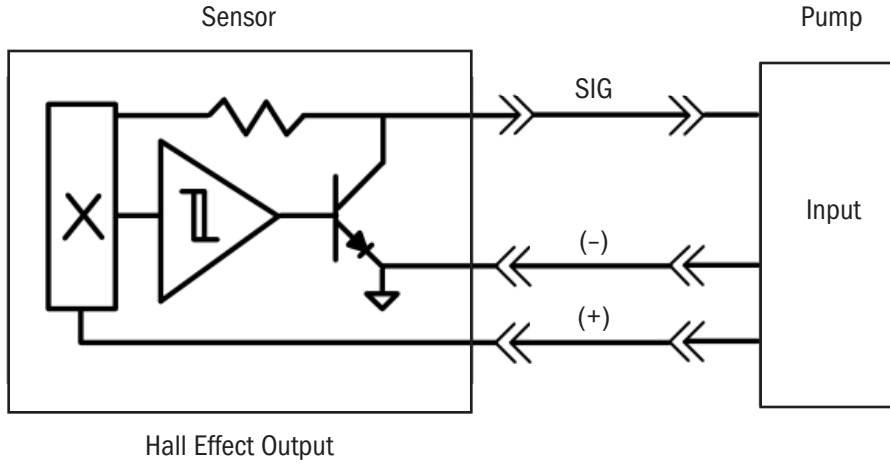

Connection Terminals

- Connect meter positive input to Hall+12VDC, position #10 on the top row.
- Connect meter common to Signal Common, position #9 on the top row.
- Connect meter signal to Pulse/PPM/Hall signal, position #8 on the top row.

1	2	3	4	5	6	7	8	9	10
Output Relay 2	Output Relay 1	Output Relay 1	Standby (+)	Standby (-)	4-20mA IN (+ signal)	0-10VDC (+ signal)	Pulse/PPM/Hall signal	Signal Common	Hall +12VDC
Output Relay 2	Output Relay 3	Output Relay 3	4-20mA OUT (-)	4-20mA OUT (+)	Leak Detect External	Leak Detect External	Flow Detect \neg L	Flow Detect (-)	Flow Detect +12VDC
11	12	13	14	15	16	17	18	19	20

⚠ CAUTION The 12VDC supply from connection #10 is limited to 20mA and is only for powering Hall Effect sensors on turbine or paddlewheel type flow meters. Do not use the 12VDC output for anything else; otherwise, damage to the pump will occur.

CONNECTIONS continued

STANDBY

The STANDBY function allows the pump to be stopped remotely. If a dry contact or open collector signal is received to the STANDBY inputs, the pump will cease operation as long as the signal is present. The pump will also flash “STANDBY” on the operating display.

The STANDBY function can be used to transfer operation to a secondary pump in the event of a primary pump failure. An output relay on the primary pump is programmed for TRANSFER and Normally Closed. This relay provides an input to the STANDBY function of the secondary pump, which is programmed identically to the primary pump. In the event of a loss of power or an alarm event that shuts down the primary pump, the output relay on the primary pump opens and activates the secondary pump.

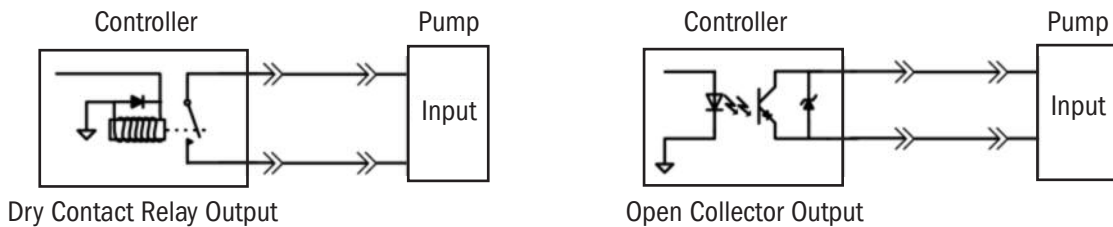

Connection Terminals

Connection to a Dry Contact

- There is no polarity to observe.
- Connect relay to Standby (+), position #4 and Standby (-), position #5 on the top row.

Connection to an Open Collector output

- Polarity must be observed.
- Connect OC positive to Standby (+), position #4 on the top row.
- Connect OC common to Standby (-), position #5 on the top row.

1	2	3	4	5	6	7	8	9	10
Output Relay 2	Output Relay 1	Output Relay 1	Standby (+)	Standby (-)	4-20mA IN (+ signal)	0-10VDC (+ signal)	Pulse/PPM/Hall signal	Signal Common	Hall +12VDC
Output Relay 2	Output Relay 3	Output Relay 3	4-20mA OUT (-)	4-20mA OUT (+)	Leak Detect External	Leak Detect External	Flow Detect \square	Flow Detect (-)	Flow Detect +12VDC
11	12	13	14	15	16	17	18	19	20

CONNECTIONS continued

OUTPUT RELAYS

Connection Terminals

The relays are dry contacts, so there is no polarity to observe.

NOTE: The output relays are Normally Open.

⚠ CAUTION The output relays are for signal level only. Max rating is for 24VDC at 50mA.

Output Relay #1

Connect to Output Relay 1 in positions #2 & #3 on the top row.

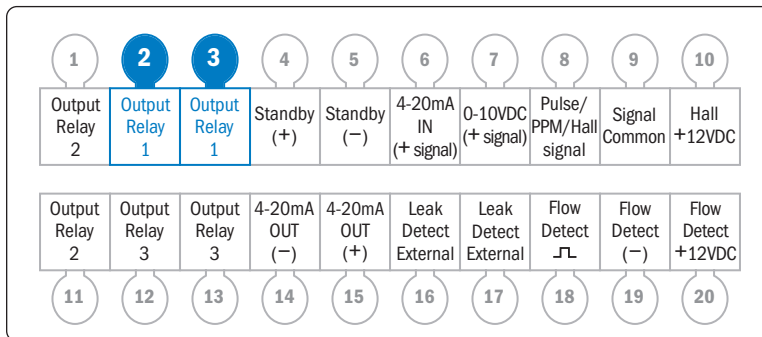

Output Relay #2

Connect to Output Relay 2 in positions #1 on the top row and #11 on the bottom row.

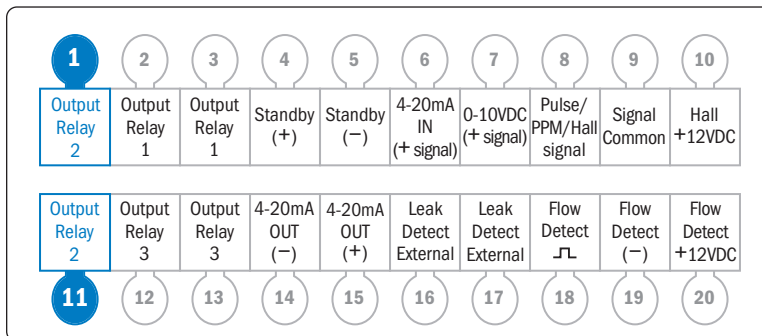

Output Relay #3

Connect to Output Relay 3 in positions #12 and #13 on the bottom row.

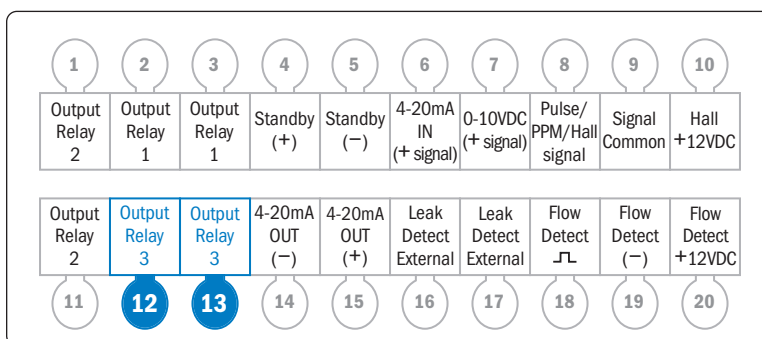

CONNECTIONS continued

4-20mA OUTPUT page 1 of 2

The pump is equipped with a 4-20 mA output signal.

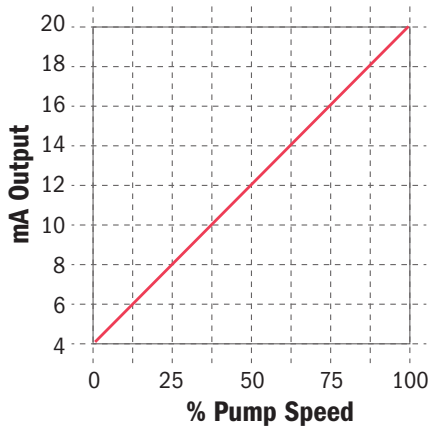

The signal corresponds proportionally to pump speed and is not adjustable.
 0% speed = 4.0mA
 100% speed = 20.0mA

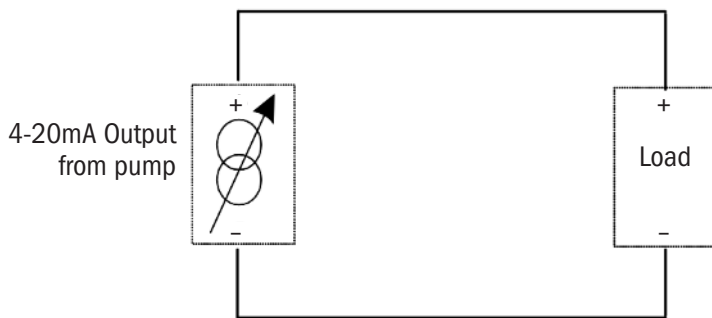

The pump sources the voltage for the output signal loop at 24VDC. The pump will control the magnitude of current on the loop (from 4 to 20mA) according to the speed that the pump is running at. The maximum loop impedance (load on the output signal loop) is 300 ohms, which includes the load plus any resistance due wire length, connections, etc.

CAUTION The loop impedance must be less than 300 ohms.

CAUTION Do not short the 4-20mA output loop. Doing so will cause the pump to shut off and may damage the pump.

CAUTION To ensure proper signal output, always calibrate the output signal.

Connection Terminals

- Connect load positive to 4-20mA OUT (+), position #15 on the bottom row.
- Connect load common to 4-20mA OUT (-), position #14 on the bottom row.

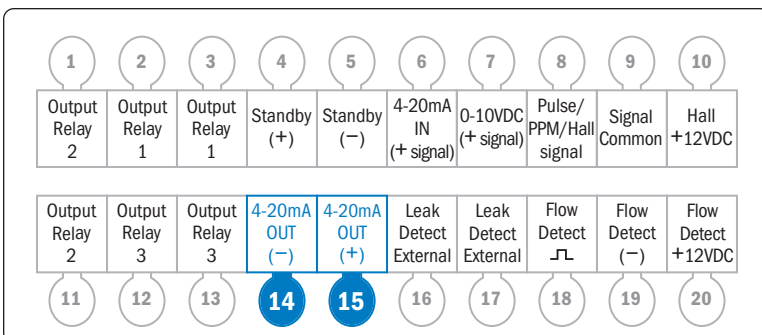

CONNECTIONS continued

4-20mA OUTPUT page 2 of 2

CALIBRATING 4-20mA OUTPUT

The 4-20mA output will produce a signal that corresponds to the speed percentage that the pump is running (4mA=0% pump speed & 20mA=100% pump speed).

To calibrate the output loop – navigate to the signal calibration selection in the configuration menu – with the pump installed – place a process or a multimeter in the loop.

NOTE: When entering this menu the output is activated only when the value is changed by pressing the up or down arrows.

Adjust the value in the “4mA out set” menu to indicate 4mA in the process loop and press enter. this is the zero adjustment parameter.

Next adjust the value in the “20mA out set” menu to indicate 20mA in the process loop and press enter. this is the span adjustment parameter.

Go to manual mode. set the pump speed at 100%. note the difference between the current loop value and 20mA – return to the output signal calibration menu and readjust (add or subtract) the output level by the difference noted.

Verify the process loop by setting the pumps speed to 25%, 50%, & 75%. the loop current should be 8mA, 12mA, & 16mA respectively.

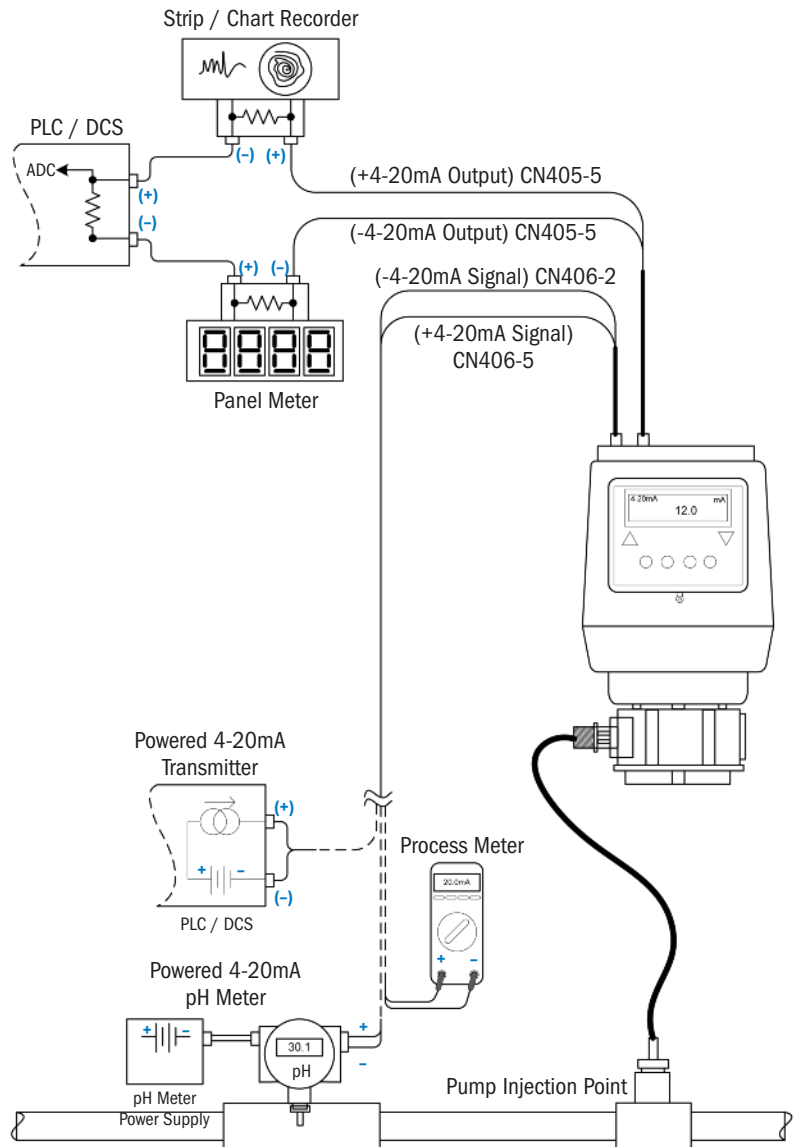

CONNECTIONS continued

LEAK DETECT page 1 of 3

The S Series pump includes a highly sensitive leak detector. The detector can differentiate between a tube rupture leak and water intrusion. The sensitivity feature reduces the number of false “tube leak” signals due to the pump’s location in a wet environment, outdoors or if subject to hose down cleaning.

⚠WARNING TO BE INSTALLED AND MAINTAINED BY PROPERLY TRAINED PROFESSIONAL INSTALLER ONLY. READ MANUAL & LABELS FOR ALL SAFETY INFORMATION & INSTRUCTIONS.

⚠CAUTION Turn off water system, disable all pumps and depressurize the system before performing installation. Always wear proper protective safety equipment when working with metering pumps.

- Field calibration of the pump in the application assures the “tube leak” signal represents the application’s chemical and concentration.
- Refer to Configuration Menu section in the pump manual to select, fine-tune and program the responses available when a “tube leak” signal is received.
- The leak detect sensitivity is factory pre-set to distinguish between water and typical water treatment chemicals. Adjust the sensitivity according to the specific chemical utilized in the application. Adjust with the potentiometer located under the signal cover, see below.
- When using external leak detect probes (not included with pump), connect to Leak Detect External, positions #16 and #17 on the bottom row of the terminal on rear of the pump. The probes can monitor leakage in areas other than the pump head. The probes should be constructed of Hastelloy® to inhibit corrosion.

NOTE: The leak detect function has one sensitivity adjustment. When external probes are used, confirm the sensitivity setting is acceptable for the probes and liquid end.

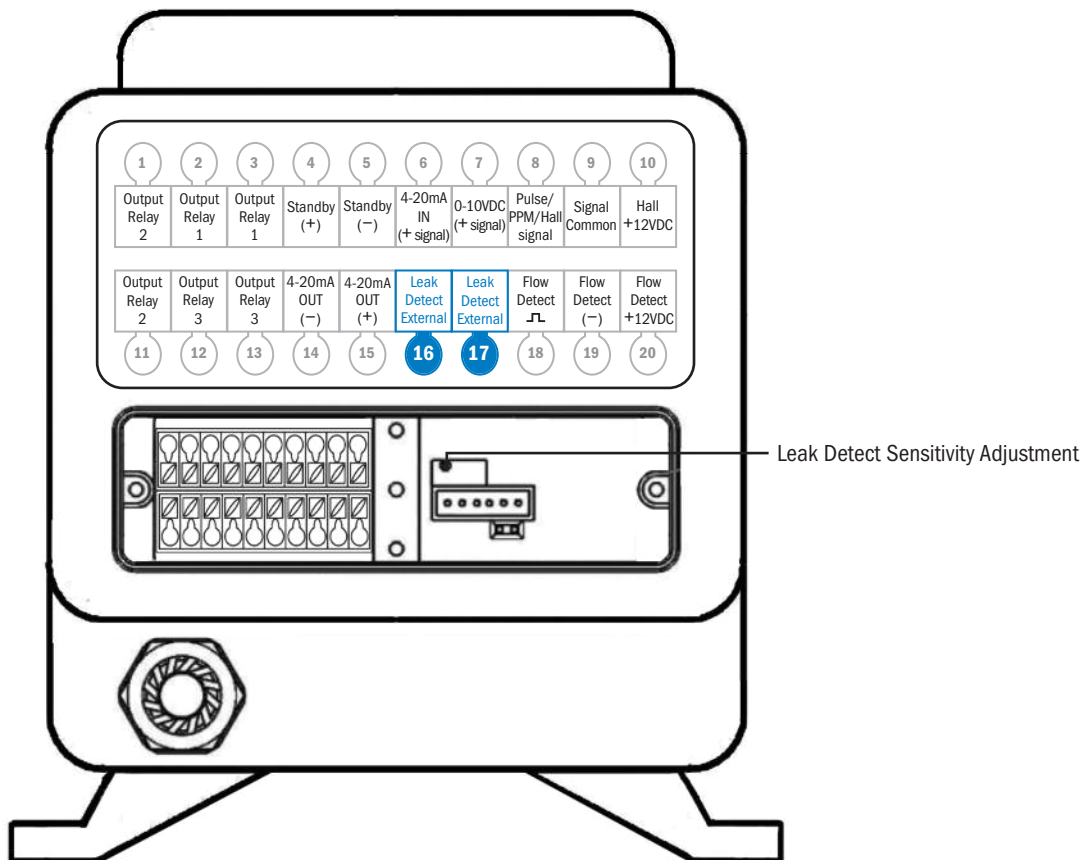

CONNECTIONS continued

LEAK DETECT page 2 of 3

CALIBRATE THE LEAK DETECT SENSITIVITY

1. In the Configuration Menu, verify that “Alarm on Tube leak” is set to NO.
2. Set the pump to MANUAL mode at 0%.
3. Unplug the pump.
4. Remove tube housing cover.
5. Remove the signal cover to allow access to the leak detect adjustment potentiometer, **A**.
6. Plug the pump in.
7. Soak a small piece of sponge with the pumping solution and place over the two leak detect pins, **B**.
In this step, use the expected weakest solution and keep in mind some solutions dilute with time.
8. Observe whether the tube leak icon is shown on the display, **C**.
 - If yes, use a small flat blade screwdriver less than 3 mm and slowly turn the leak detect potentiometer clockwise, **A**, until the tube leak icon is not displayed, then proceed to step 9.
 - If the pump does not display the tube leak icon, proceed to step 9.

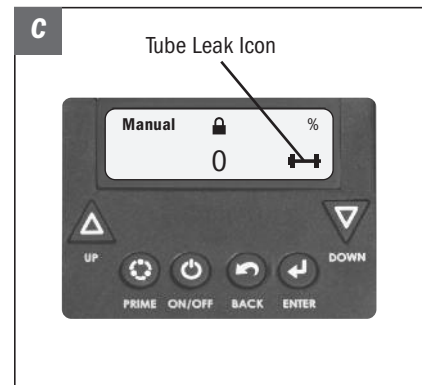
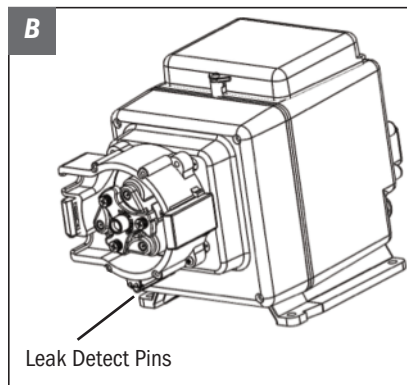
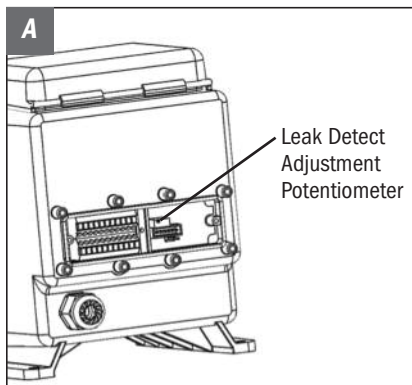

CONNECTIONS continued

LEAK DETECT page 3 of 3

CALIBRATE THE LEAK DETECT SENSITIVITY

9. Use a small flat blade screwdriver less than 3 mm and slowly turn the potentiometer counterclockwise until the tube leak icon is visible and not flickering, **C**. Turn slightly past this point to ensure a solid tube leak icon is shown.
10. Thoroughly clean the solution off the pins and confirm they are dry, **B**. Confirm the tube leak icon is not displayed.
IMPORTANT: Confirm there is no chemical residue remaining on the leak detect pins and bracket, **B**.
11. If the pump is not outdoors or exposed to water, go to Reassembly.
12. If the pump will be installed outdoors or exposed to water:
 - Soak a small piece of sponge in water and place over the two leak detect pins, **B**. If the tube leak icon displays, **C**, it indicates the conductivity of the pumped solution and water is too close and the pump cannot discriminate between the two. The liquid end needs to be protected from water intrusion to avoid a false tube leak signal.
 - If the tube leak icon does not show, the setting is complete.
13. Reinstall the tube housing cover and the signal cover on the pump.
14. Prime the pump, enable leak detect and set the mode of operation.
15. Verify pump operation.

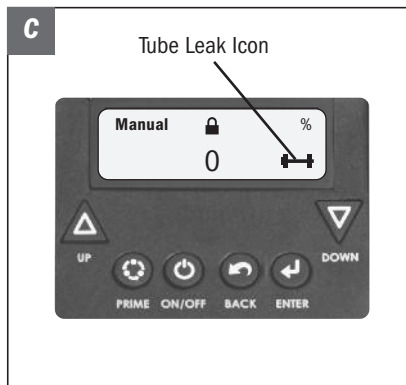
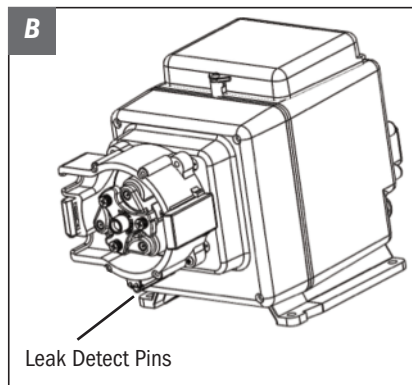

INSTALLATION

ADDITIONAL SAFETY INSTRUCTIONS

! **NOTICE:** Indicates special instructions or general mandatory action.

- !** Read all safety hazards before installing or servicing the pump. The pump is designed for installation and service by properly trained personnel.
- !** Use all required personal protective equipment when working on or near a chemical metering pump.
- !** Install the pump so that it is in compliance with all national and local plumbing and electrical codes.
- !** Use the proper product to treat potable water systems, use only chemicals listed or approved for use.
- !** Inspect tube frequently for leakage, deterioration, or wear. Schedule a regular pump tube maintenance change to prevent chemical damage to pump and/or spillage.
- !** Recommended mounting is vertical with pump head pointed downward.

INSTALLATION continued

MOUNT PUMP

- ❗ Recommended mounting is vertical with pump head pointed downward.
 - ❗ Select a dry location (to avoid water intrusion and pump damage) above the solution tank. Best recommended location is above the solution tank in a vertical position with the pump head pointed downward.
 - ❗ To prevent pump damage in the event of a pump tube leak, never mount the pump vertically with the pump head up.
 - ❗ To avoid chemical damage from fumes, DO NOT mount pump directly over an open solution tank. Keep tank covered.
 - ❗ Avoid flooded suction or pump mounted lower than the solution container. Draw solution from the top of the tank. Pump can run dry without damage. If pump is installed with a flooded suction, a shut-off valve or other device must be provided to stop flow to pump during service.
 - ❗ Provide 8" clearance to allow pump removal.
 - ❗ To prevent damage, verify with a volt meter that the receptacle voltage corresponds with the pump voltage.
1. Use the mounting bracket as a template to drill pilot holes in mounting location.
 2. Secure bracket with fasteners or wall anchors. Slide pump into bracket.

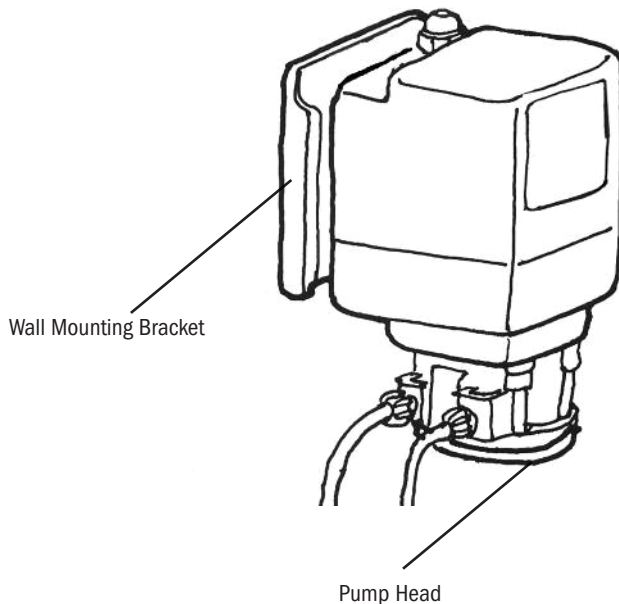

INSTALLATION continued

DIAGRAM

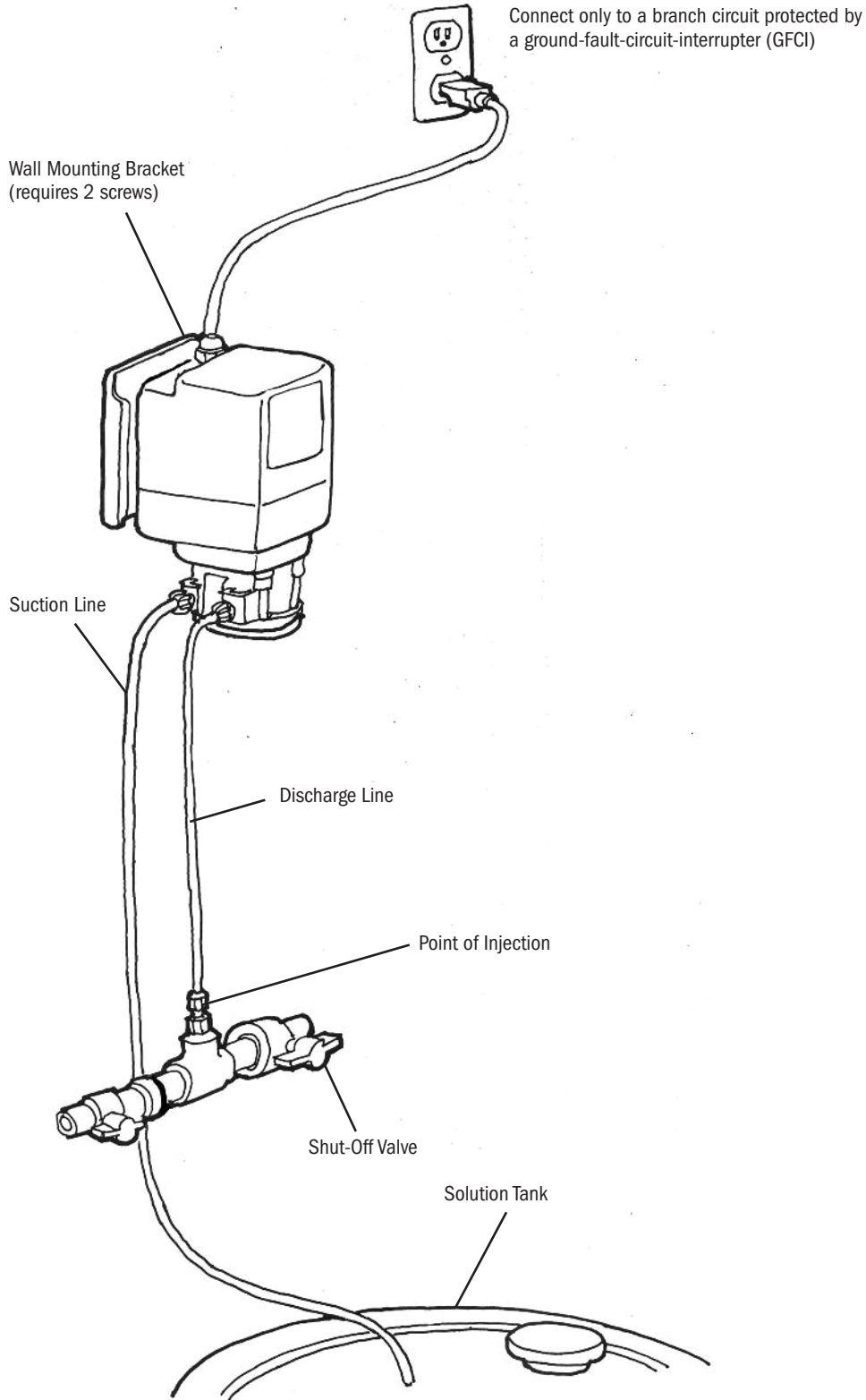

INSTALLATION continued

INSTALL SUCTION LINE TO PUMP HEAD

1. Uncoil the suction/discharge line. Use outside of solution tank as a guide to cut proper length of suction line ensuring it will be 2-3" above the bottom of solution tank.

❗ **Allow sufficient slack to avoid kinks and stress cracks. Always make a clean square cut to assure that the suction line is burr free. Normal maintenance requires trimming.**

❗ **Suction lines that extend to the bottom of the tank can result in debris pickup leading to clogged injectors and possible tube failure.**

2. Make connections.

S30 Models

1/4" Slide line through connecting nut and ferrule and insert into tube fitting until it stops. Firmly hold the tube fitting and finger tighten nut.

3/8" Finger tighten the adapter onto the tube fitting. Slide line through connecting nut and insert into adapter until it stops. Firmly hold adapter and finger tighten nut. Then wrench tighten nut one additional half turn. If leak occurs, gradually tighten nut as required.

S40 & S50 Models

3/8" Slide line through connecting nut and insert into the tube fitting until it stops. Firmly hold the tube fitting and finger tighten nut. Then wrench tighten nut one additional half turn. If leak occurs, gradually tighten nut as required.

3. Finger tighten nut to the threaded tube fitting while holding the tube fitting.

❗ **Over tightening the ferrule and nut may result in damaged fittings, crushed ferrules, and air pick up.**

❗ **DO NOT use thread seal tape on pump tube connections.**

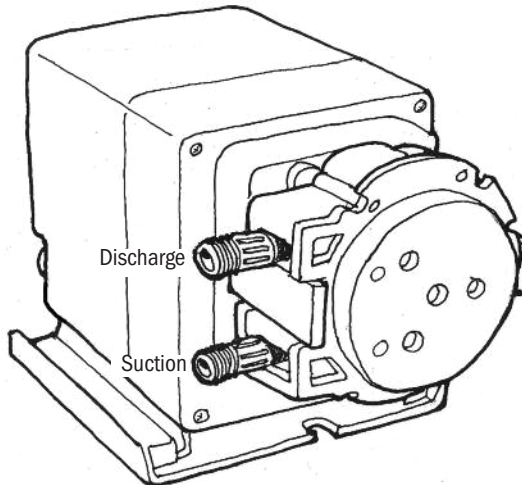
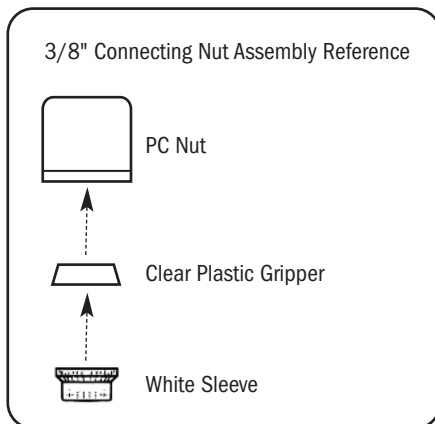

NOTE: Suction/Discharge lines should bottom into all fittings.



DO NOT use thread seal tape on pump tube threads.

INSTALLATION continued

INSTALL SUCTION WEIGHT TO SUCTION LINE

1. Drill a hole into the bung cap or solution tank lid. Slide the suction line through and secure the weighted strainer to the line.
2. To attach the strainer, push approximately 3.5" of suction line through the cap on the strainer body. Pull suction line to make sure it is secure.
3. Suspend slightly above tank bottom to reduce the chance of sediment pickup.

! **DO NOT mix chemicals in the solution container. Follow recommended mixing procedures according to the manufacturer.**

! **DO NOT operate pump unless chemical is completely in solution. Turn pump off when replenishing solution.**

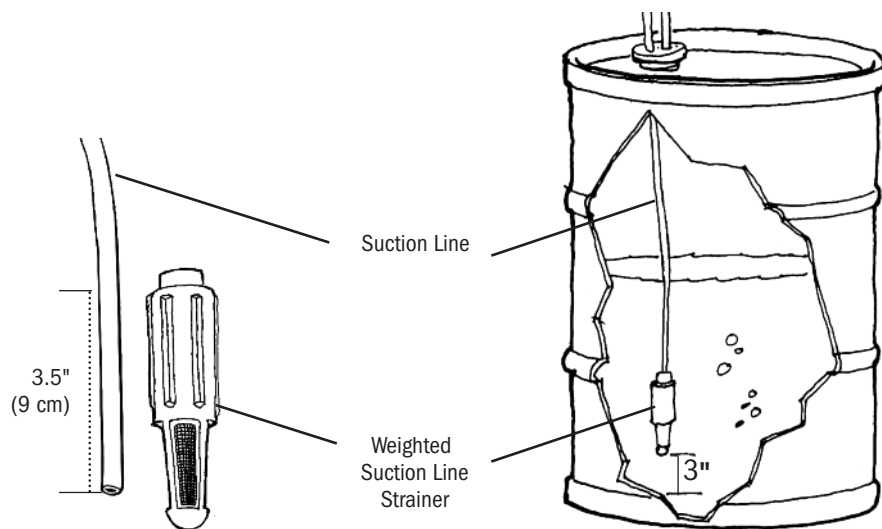

INSTALLATION continued

INSTALL DISCHARGE LINE TO PUMP HEAD AND INJECTION POINT

1. Make a secure finger tight connection on the discharge fitting of the pump head as instructed in Install Suction Line instructions.

! DO NOT use thread seal tape on pump tube connections or tools to tighten connections.

! **WARNING** HAZARDOUS PRESSURE: Shut off water or circulation system and bleed off any system pressure.

! Locate a point of injection beyond all pumps and filters or as determined by the application.

2. Make connections.

S30 Models

1/4" Slide line through connecting nut and ferrule and insert into tube fitting until it stops. Firmly hold the tube fitting and finger tighten nut.

3/8" Finger tighten the adapter onto the tube fitting. Slide line through connecting nut insert into adapter until it stops. Firmly hold adapter and finger tighten nut. Then wrench tighten nut one additional half turn. If leak occurs, gradually tighten nut as required.

S40 & 50 Models

3/8" Slide line through connecting nut and insert the line into the tube fitting until it stops. Firmly hold the tube fitting and finger tighten nut. Then wrench tighten nut one additional half turn. If leak occurs, gradually tighten nut as required.

3. Wrap the Male NPT (MNPT) end of injection fitting with 2 or 3 turns of thread seal tape. If necessary, trim the injection fitting quill as required to inject product directly into flow of water.

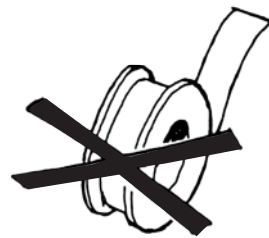
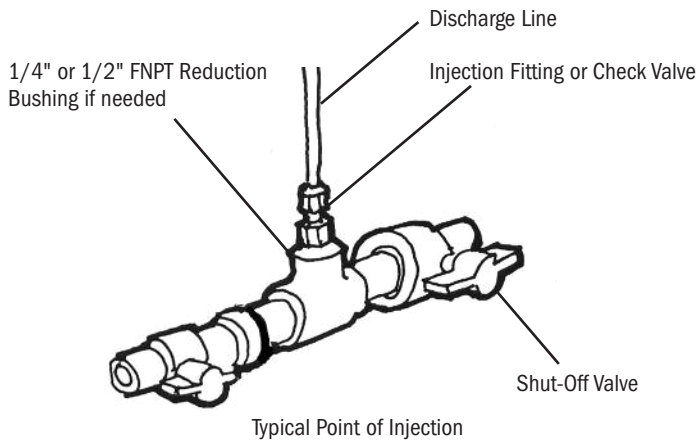

DO NOT use thread seal tape on pump tube threads.

INSTALLATION continued

4. Hand tighten the injection fitting into the FNPT fitting.

Injection Fitting (S30 – 25 psi max.)

- 1/4" Slide line through connecting nut and ferrule and insert into injection fitting until it stops. Finger tighten nut.
- 3/8" Slide line through connecting nut and insert into injection fitting until it stops. Finger tighten nut. Then wrench tighten nut one additional half turn. If leak occurs, gradually tighten nut as required.

Duckbill Check Valve or Ball Check Valve

Prior to connection, test check valve and NPT threads for leaks by pressurizing system. If necessary, tighten an additional quarter turn.

- 1/4" Slide line through connecting nut and ferrule and insert into check valve body until it stops. Finger tighten nut.
 - 3/8" Slide line through connecting nut and insert into check valve body until it stops. Finger tighten nut. Then wrench tighten nut one additional half turn. If leak occurs, gradually tighten nut as required.
5. Depress and hold the prime button and allow pump to fully prime. The prime button will run the pump and when released the pump will return to automatic mode.
 6. Re-pressurize system, observe chemical flow as actuated by system and check all connections for leaks.
 7. After suitable amount of dosing time, perform tests for desired chemical readings. If necessary, fine tune dosing levels by adjusting solution strength.
-  **The injection point and fitting require periodic maintenance to clean any deposits or buildup. To allow quick access to the point of injection, Stenner recommends the installation of shut-off valves.**

TROUBLESHOOTING – MOTOR

 **WARNING** HAZARDOUS VOLTAGE: DISCONNECT power cord before removing motor cover for service.
Electrical service should be performed by trained personnel only.

PROBLEM	POSSIBLE CAUSE	SOLUTION
Display is blank or not readable	No power cord connection point Failed power supply Pump requires re-initialization Display is too dim	Check voltage of receptacle/controller output voltage Return to factory for evaluation Cycle power to the pump Increase display brightness in the CONFIGURATION menu
No response to input signal	Pump is in alarm or STANDBY condition Pump is not in the correct mode No signal or improper signal level input to the pump Input signal is not wired correctly	Clear and correct any alarm or indicated conditions (leak detect, standby, etc.) Ensure that pump has been programmed for the correct input signal and that the operating display shows the desired mode of operation If in signal mode, confirm signal level input to the pump by looking for the icon on the screen Confirm that the input signal is connected to the correct wires
Output is erratic	Signal is fluctuating rapidly Noise on the signal wire	Check stability of signal being input to the pump If shielded wire is connected to the pump input signal cable, ensure it is properly grounded at the signal source
Output is higher or lower than expected	Signal is fluctuating rapidly Pump calibration data is incorrect Input signal level is higher or lower than anticipated	Check programming, ensure the values entered are correct Check that the value entered for CALIBRATION in the CONFIGURATION menu is correct Check input signal level to the pump
Pump cycles ON/OFF	Failed fan Pump is too hot Red (+12VDC) wire on the signal cable is not capped and insulated (if not terminated) Load too high or shorted on 4-20mA output	Return to factory for evaluation Check that maximum ambient temperature is less than 104°F; Shade pump if exposed to direct sunlight Cap and insulate the Red wire to prevent it from shorting Maximum loop impedance is 300mA; Ensure output is not shorted

TROUBLESHOOTING – MOTOR continued

PROBLEM	POSSIBLE CAUSE	SOLUTION
Display is working, pump is not	<p>Pump requires re-initialization</p> <p>Failed motor</p> <p>Pump is in alarm or STANDBY</p> <p>Pump is not in the correct mode</p> <p>No signal or improper signal level input to the pump</p> <p>Input signal is not wired correctly</p>	<p>Cycle power to the pump</p> <p>Return to factory for evaluation</p> <p>Clear and correct any alarm or indicated conditions (leak detect, standby, etc.)</p> <p>Ensure that pump has been programmed for the correct input signal and that the operating display shows the desired mode of operation</p> <p>If in signal mode, confirm signal level being input to the pump is correct</p> <p>Confirm that the input signal is connected to the correct wires</p>
Pump does not alarm for given condition	<p>Incorrect programming or alarm condition not set up</p> <p>Relay is incorrectly configured</p> <p>Relay output wired incorrectly</p>	<p>Ensure that alarm is enabled for the programmed mode</p> <p>Ensure relay is properly configured for NO or NC in the program</p> <p>Output relays are dry contact and do not provide any voltage; Confirm that wiring is correct</p>
Operating display shows incorrect units	<p>Incorrect programming</p> <p>Display unit has been cycled</p>	<p>Check that the value entered for UNITS in the CONFIGURATION menu is correct</p> <p>Press the BACK button to cycle through available display options</p>
Can't enter Main Menu	<p>Forgot password</p>	<p>Contact the factory for password reset</p>
Leak detect not working	<p>Incorrect programming</p> <p>Leak detect components are missing or not making contact properly</p> <p>Leak detect sensitivity was calibrated incorrectly</p>	<p>Ensure that alarm is enabled for the programmed mode</p> <p>Confirm the leak detect pins or wires make contact with the pump head cover and motor case or transition sleeve ball detents</p> <p>Follow the leak detect sensitivity calibration instructions</p>
Excessive head movement S50 model	<p>Thumbscrews not fully tightened</p> <p>Worn or damaged cover bearing</p> <p>Missing transition sleeve or pump head support</p>	<p>Tighten thumbscrews to secure cover</p> <p>Replace cover and ensure that pump head support is installed</p> <p>Replace transition sleeve or pump head support</p>

TROUBLESHOOTING – PUMP HEAD

PROBLEM	POSSIBLE CAUSE	SOLUTION
S30 Roller Assembly will not expand or collapse with tube housing cover	Stripped or cracked roller assembly hub New tube is not relaxed	Replace roller assembly With cover latched, run the roller assembly in collapsed position for four minutes
Components cracking	Chemical attack Chemical intrusion from tube failure	Check chemical compatibility Identify and correct cause, clean components of chemical and replace tube according to manual
Pump head leaking	Pump tube rupture	Identify and correct cause, clean components of chemical and replace tube according to manual
No pump output, pump head rotates	S30 Roller assembly not fully expanded Depleted solution tank Pump suction line weight is above solution Leak in the suction line or at connections 1/4" ferrules installed incorrectly, missing or damaged Sleeve and/or gripper inside 3/8" nut is missing, damage, or incorrectly assembled Injection point is clogged Clogged suction and/or discharge line and/or check valve Life of roller assembly exhausted Life of pump tube exhausted Suction line is flush with the nose of the weighted strainer	Expand roller assembly according to manual Replenish solution Maintain suction line 2-3" above bottom of tank Replace suction line and/or repair connections Replace ferrule; beveled end faces pump. Suction/Discharge lines should bottom into tube fittings. Replace nut and confirm orientation: gripper beveled end faces nut & sleeve wide end faces gripper. Diagram in Installation section. Inspect and clean injection point Clean and/or replace as needed Replace roller assembly Replace tube according to manual, schedule tube replacement based on application Pull suction line approximately 1" from bottom of strainer, cut bottom of suction line at an angle

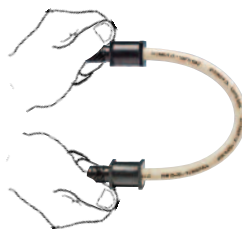

S40 & S50 Models

IMPORTANT: DO NOT TWIST THE TUBE during installation. To ensure it doesn't twist, keep the tube positioned so the printed description stays aligned along the length of the tube.

TROUBLESHOOTING – PUMP HEAD continued

PROBLEM	POSSIBLE CAUSE	SOLUTION
Low pump output, pump head rotates	Life of pump tube exhausted	Replace tube, according to manual, schedule tube replacement based on application
	Life of roller assembly exhausted	Replace roller assembly
	Injection point is restricted	Inspect and clean injection point regularly
	Incorrect tube size or setting	Install correct tube size according to manual or adjust settings
	High system back pressure	Verify system pressure against tube psi, replace tube if needed according to manual
No pump output, pump head doesn't rotate	Stripped roller assembly	Replace roller assembly
	Motor problem	Refer to motor section
Pump output high	Incorrect tube size or setting	Install correct tube size according to manual or adjust settings
	Roller assembly broken	Replace roller assembly





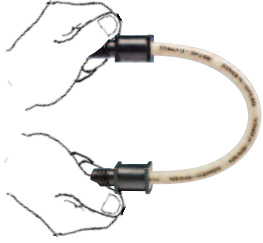

TROUBLESHOOTING – PUMP TUBE

NOTICE: A leaking pump tube damages the metering pump. Inspect pump frequently for leakage and wear. Refer to Tube Replacement section for additional safety precautions and instructions.

PROBLEM	POSSIBLE CAUSE	SOLUTION
Tube leaking	<p>Pump tube ruptured</p> <p>Calcium or mineral deposits</p> <p>Excessive back pressure</p> <p>S30 Tube is twisted or not centered</p> <p>S40 & S50 Tube is twisted</p> 	<p>Replace pump tube, ferrules; center tube</p> <p>Clean injection fitting, replace pump tube, ferrules; center tube</p> <p>Verify system pressure against tube psi, replace tube if needed</p> <p>Replace pump tube according to manual; center tube</p> <p>Replace the tube according to manual</p> <p>IMPORTANT: DO NOT TWIST THE TUBE during installation. To ensure it doesn't twist keep the tube positioned so the printed description stays aligned along the length of the tube. Use your fingers to center the tube on the rollers.</p>
Tube life is shortened	<p>Chemical attack</p> <p>Mineral deposits at injection point</p> <p>Sediment blockage at check valve</p> <p>Degraded check valve components</p> <p>Check valve components in wrong orientation</p> <p>Tube manually stretched or pinched during replacement</p> <p>Seized rollers caused abrasion on tube</p> <p>Exposure to heat or sun</p>	<p>Check chemical compatibility</p> <p>Clean injection point. Replace tube & check check valve components according to manual</p> <p>Clean injection fitting, ensure suction line is 2-3" above bottom of tank; Use suction line strainer.</p> <p>Replace degraded check valve components</p> <p>Refer to Cleaning Injection Point section</p> <p>Follow tube replacement instructions</p> <p>Clean roller assembly or replace, do not lubricate</p> <p>Do not store tubes in high temperatures or in direct sunlight</p>
Tube connection is leaking 1/4"	1/4" ferrules installed incorrectly, missing or damaged	Replace ferrule; beveled end faces pump. Suction/Discharge lines should bottom into tube fittings.
3/8"	<p>3/8" nut loose</p> <p>Missing ferrule in 3/8" adapter</p> <p>Sleeve and/or gripper inside 3/8" nut is missing, damaged or incorrectly assembled</p>	<p>Firmly hold tube fitting or adapter and finger tighten nut; wrench tighten additional 1/2 turn</p> <p>Insert new ferrule into adapter or replace adapter</p> <p>Replace nut and confirm orientation; gripper beveled end faces nut & sleeve wide end faces gripper.</p>

TUBE REPLACEMENT – SAFETY INFORMATION



WARNING RISK OF CHEMICAL EXPOSURE

-  To reduce risk of exposure, check the pump tube regularly for leakage. At the first sign of leakage, replace the pump tube.
-  To reduce risk of exposure, the use of proper personal protective equipment is mandatory when working on or near chemical metering pumps.
-  To reduce risk of exposure, and also prior to service, shipping, or storage, pump generous amounts of water or a compatible buffer solution to remove chemical from pump.
-  Consult chemical manufacturer and SDS sheet for additional information and precautions for the chemical in use.
-  Personnel should be skilled and trained in the proper safety and handling of the chemicals in use.
-  Inspect tube frequently for leakage, deterioration, or wear. Schedule a regular pump tube maintenance change to prevent chemical damage to pump and/or spillage.





CAUTION PINCH POINT HAZARD

-  Use extreme caution when replacing pump tube. Be careful of your fingers and do not place fingers near rollers.

WARNING HAZARDOUS PRESSURE/CHEMICAL EXPOSURE

-  Use caution and bleed off all resident system pressure prior to attempting service or installation.
-  Use caution when disconnecting discharge line from pump. Discharge may be under pressure. Discharge line may contain chemical.

NOTICE: Indicates special instructions or general mandatory action.

-  **DO NOT** apply grease, oil, or lubricants to the pump tube or housing.
-  Prior to pump tube replacement, inspect the entire pump head for cracks or damaged components. Ensure rollers turn freely.
-  Rinse off chemical residual and clean all chemical and debris from pump head components prior to tube replacement. Apply AquaShield to main shaft and tube housing cover bushing during tube replacement.
-  Avoid kinks or damage during tube installation.
-  Inspect the suction and discharge lines, injection point (into pipe), and injection check valve duckbill for blockages after any tube rupture. Clear or replace as required.

S30 TUBE REPLACEMENT

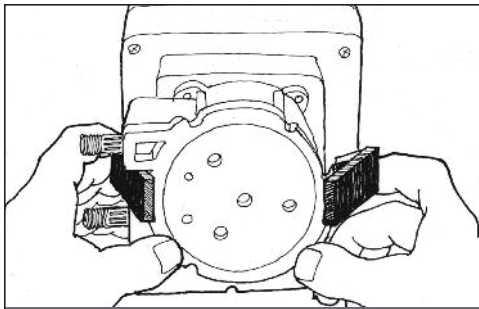

A Open latches

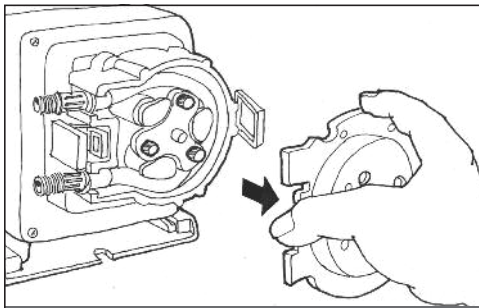

B Remove cover

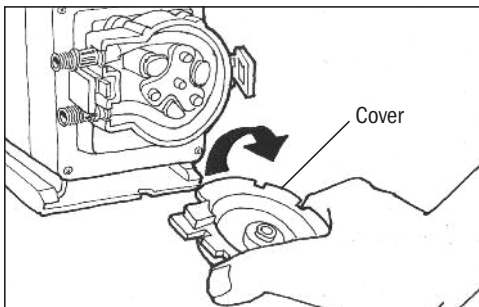

C Invert cover

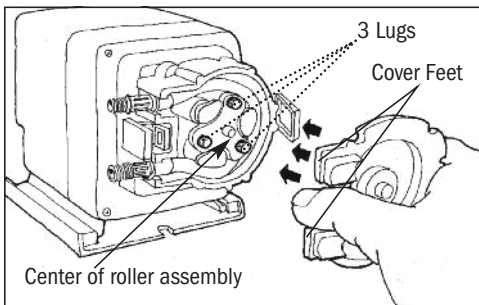

D Align cover feet near tube fitting

PREPARATION

1. Follow all safety precautions prior to tube replacement.
2. Prior to service, pump water or a compatible buffer solution through the pump and suction and discharge lines to remove chemical and avoid contact.

REMOVE THE PUMP TUBE

1. Unplug the power cord to ensure the power to the pump is off. Disconnect the input signal.
2. Depressurize and disconnect the suction and discharge lines.
3. Open the back and front of the latches on both sides of the head. **A**
For CE pump only: Remove the safety screw on cover.
4. Remove the tube housing cover and flip to use as a tool in the next step. **B & C**
5. Align the center of the inverted cover with the center of the roller assembly so that the three holes on the face of the cover align with the three knurled lugs on the roller assembly. Position the cover feet near the tube fittings. **D**

NOTE: The roller assembly needs to be collapsed to remove the tube.

S30 TUBE REPLACEMENT continued

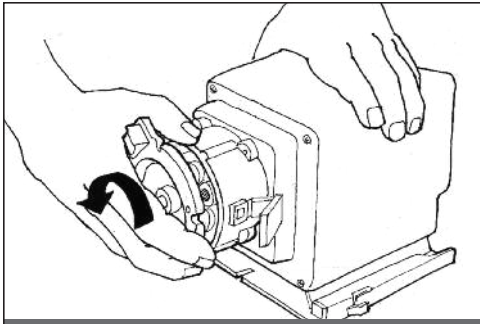

E Collapse roller assembly

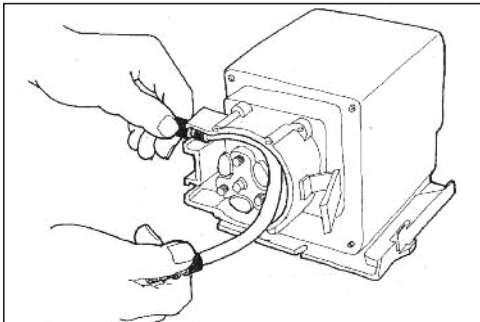

F Remove tube

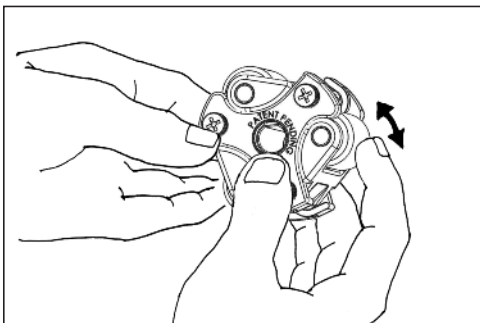

G Check rollers

REMOVE THE PUMP TUBE continued

- 6.** Collapse the roller assembly.
Hold the pump securely, use the tube housing cover as a wrench and quickly (snap) rotate the cover counterclockwise to collapse the roller assembly. The tube will no longer be pressed against the tube housing wall. **E**
- 7.** Remove and discard the pump tube. **F**
- 8.** Remove the roller assembly and housing. Set them aside to reinstall later.
- 9.** Use a non-citrus all-purpose cleaner to clean chemical residue from the tube housing, roller assembly and cover.
- 10.** Check the housing for cracks. Replace if cracked.
- 11.** Ensure the rollers turn freely. Replace the roller assembly if the rollers are seized or worn or if there is a reduction or lack of output from the pump. **G**
- 12.** Reinstall clean tube housing.
- 13.** Lightly apply AquaShield along the entire shaft.
- 14.** Reinstall the roller assembly.

S30 TUBE REPLACEMENT continued

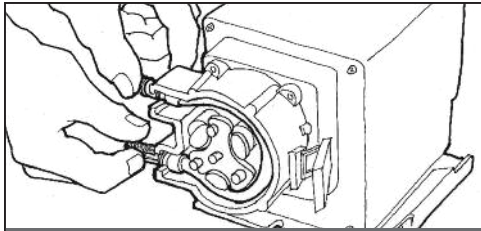

H Place new tube

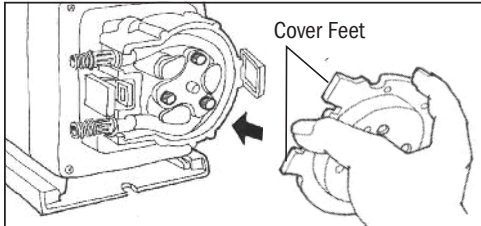

I Install cover feet first

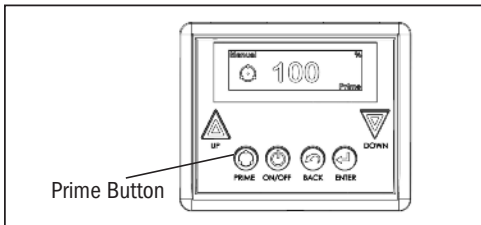

J Depress the prime button

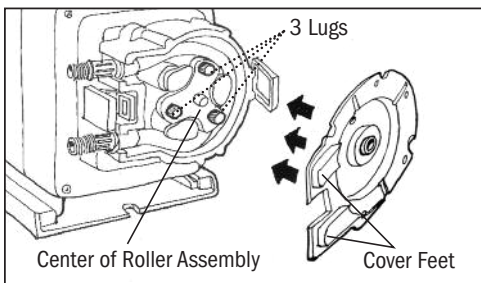

K Align cover feet near bottom

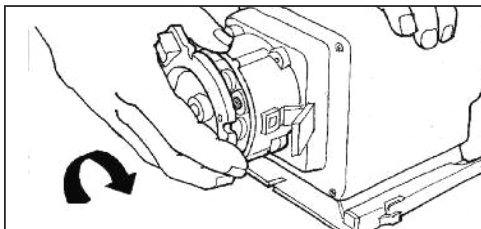

L Expand roller assembly

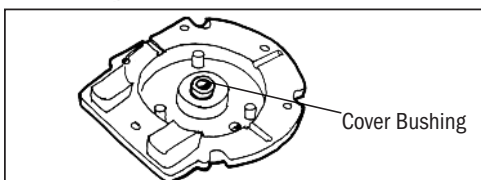

M Apply Aquashield to cover bushing

INSTALL THE TUBE/ EXPAND THE ROLLER ASSEMBLY

1. Ensure the power to the pump is off and the input signal is disconnected.
2. Install the tube. Place the new tube in the pump head and use your fingers to center it on the rollers. **H**
3. Place the tube housing cover (feet first) on the tube housing, affix the front of the latches to the cover lip and then press the latches back to secure. Be sure the cover is seated with the sleeve bearing on the shaft and is flush with the housing before latching. **I**
4. With the cover latched, plug the pump in. Depress the prime button to allow the pump to run the roller assembly in its collapsed position for four minutes. **J**
5. Unplug the power cord to ensure the power to the pump is off.
6. Remove the tube housing cover and flip to use as a tool in the next step.
7. Align the center of the inverted cover with the center of the roller assembly so that the three holes on the face of the cover align with the three knurled lugs on the roller assembly. Position the cover feet near the bottom. **K**
NOTE: The roller assembly needs to be expanded so the tube is pressed against the tube housing wall.
8. Hold the pump securely. Use the cover as a wrench and quickly (snap) rotate the roller assembly clockwise to expand the roller assembly. The tube will be pressed against the tube housing wall. **L**
9. Apply a small amount of AquaShield to the cover bushing ONLY. DO NOT lubricate the pump tube. **M**
10. Place the tube housing cover (feet first) on the tube housing, affix the front of the latches to the cover lip and then press the latches back to secure. Be sure the cover is seated with the sleeve bearing on the shaft and is flush with the housing before latching. **I**

S30 TUBE REPLACEMENT continued

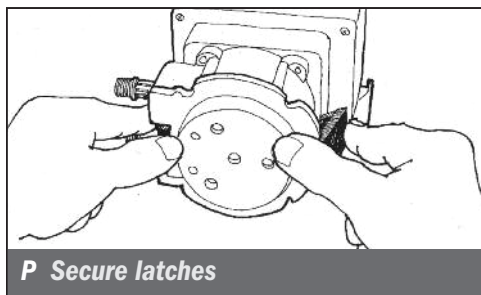
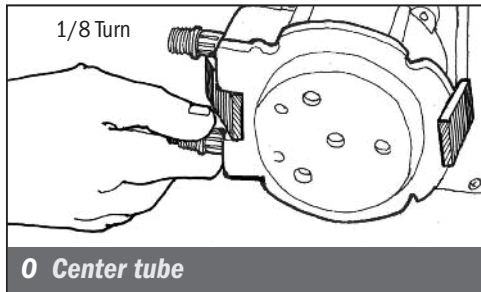
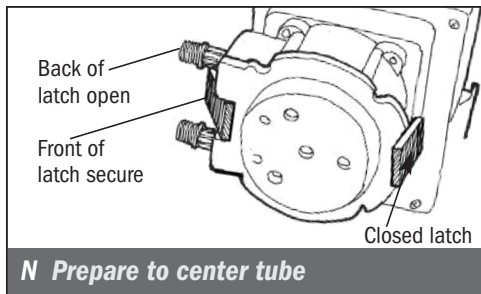

CENTER THE TUBE & FINAL INSTALLATION

1. Lift the latch located between the tube fittings, leaving the end of the latch engaged with the lip on the tube housing cover. Leave the latch on the opposite side engaged. **N**
2. Plug the pump in. Depress the prime button and turn the tube fitting on the suction side not more than 1/8 of a turn in the direction the tube must move. **O**
3. Do not let go of the fitting until the tube rides approximately in the center of the rollers.
4. Release the prime button, let go of the fitting, and secure the latch between the fittings. **P**
5. Inspect the suction and discharge lines, point of injection, and check valve for blockages. Clean and/or replace as required.
6. Reconnect the suction and discharge lines.
7. Prime pump and verify operation.
8. Place pump in desired operating mode.

S40 & S50 TUBE REPLACEMENT

The illustrations show the S5 Pump Head.

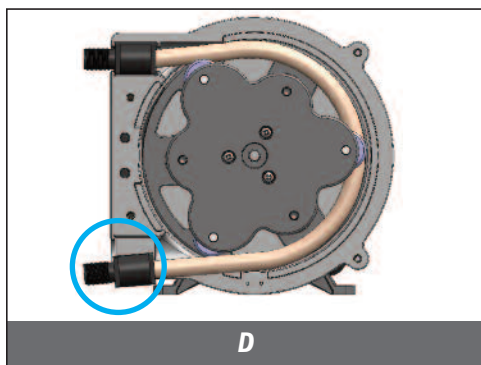
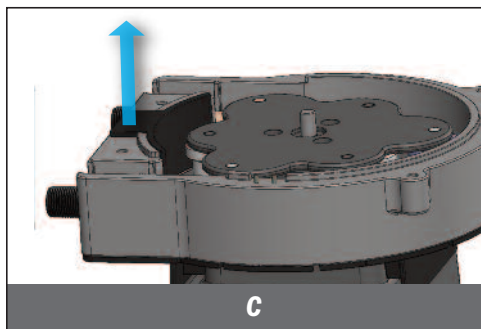
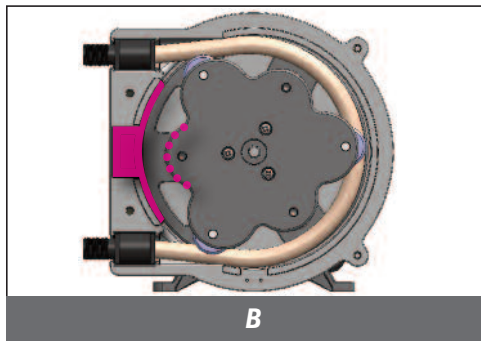
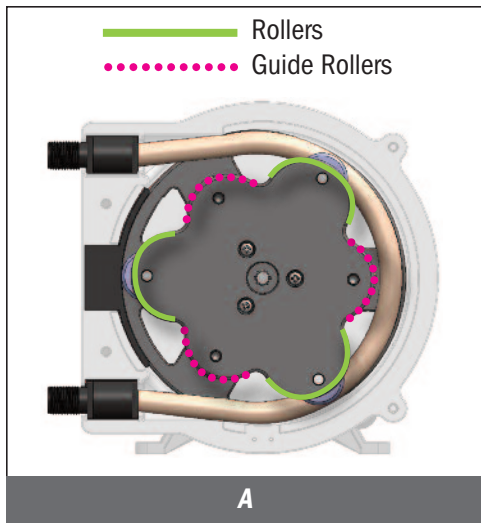

PREPARATION

1. Follow all safety precautions prior to tube replacement.
2. Prior to service, pump water or a compatible buffer solution through the pump and suction and discharge lines to remove chemical and avoid contact.
3. Identify rollers and guide rollers in the roller assembly **A**.

REMOVE THE PUMP TUBE

⚠ WARNING PINCH POINT Pump rollers are a pinch point risk. Tube installations must use tube pull. Keep fingers away from roller assembly while pump is on.

1. Disconnect the input signal.
2. Depressurize and disconnect suction and discharge lines.
3. Unscrew thumbscrews and remove tube housing cover. Set aside to reinstall later.

CE pump: remove Phillips head screws.

4. Set pump to Manual mode and set speed to 10%.
5. Press ON/OFF button to rotate roller assembly until one guide roller is aligned with the center of the pump head support. **B**
6. Remove pump head support. Replace if worn or damaged. Set aside to reinstall later. **C**
7. Turn pump on and close control panel cover.
8. Hold pump securely with one hand. With other hand, lift the tube fitting out of the suction slot in the tube housing. **D**
9. Walk tube out while roller assembly slowly rotates. Discard pump tube.
10. Turn pump off and close control panel cover.
11. Remove and inspect the roller assembly. If rollers are seized, worn, or if there is a reduction or lack of output from the pump, replace.
12. Use a non-citrus all-purpose cleaner to clean chemical residue from tube housing, roller assembly, pump head support and cover.
13. Check housing and cover for cracks. Replace if cracked.
14. Lightly apply AquaShield along the entire shaft.
15. Reinstall roller assembly.

S40 & S50 TUBE REPLACEMENT continued

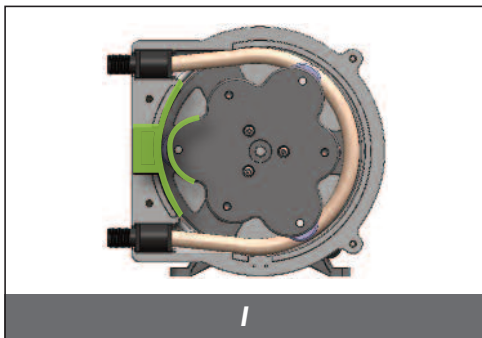
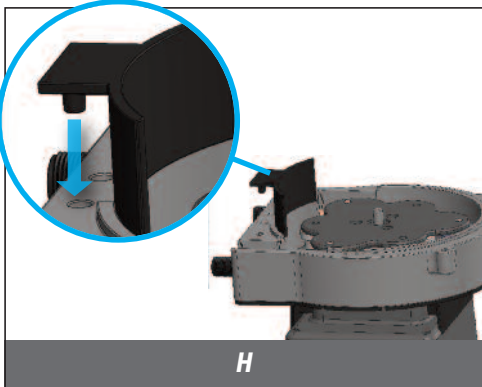
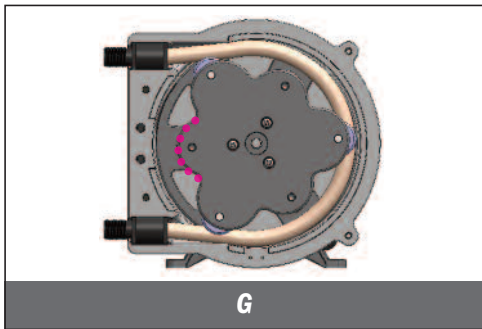
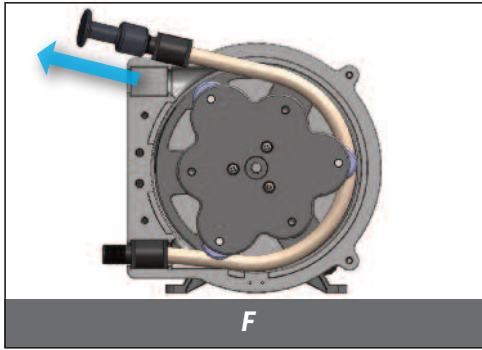
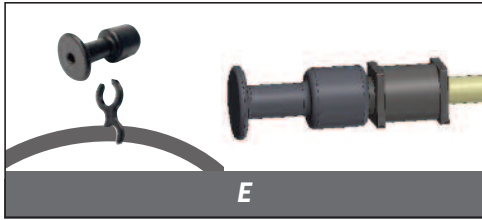

INSTALL THE TUBE

1. Ensure the input signal is disconnected.
2. Ensure pump is off and control panel cover is closed.
3. Turn pump off and close the control panel cover.
4. Remove tube pull from the holder on the power cord and screw securely onto one tube fitting. **E**
5. Place the other tube fitting into the suction side of tube housing.
6. Run pump at 10% speed and close control panel cover.
7. Hold pump securely with left hand and hold tube pull with right hand. With slight tension, walk tube around the roller assembly, take care not to let the fitting slip out of the housing. Once tube is mostly installed use the tube pull to draw the fitting towards you into the discharge slot of the tube housing. **F**



IMPORTANT: DO NOT TWIST THE TUBE during installation. To ensure it doesn't twist, keep the tube positioned so the printed description stays aligned along the length of the tube.

8. Turn pump off and close control panel cover.
9. Unscrew tube pull from the tube fitting and return it to holder on the power cord.
10. Press ON/OFF button to rotate roller assembly until one guide roller is centered between each tube fitting. **G**
11. Reinstall pump head support by pressing it into place. **H**
12. Press ON/OFF button to rotate roller assembly until one roller is aligned with the center of the pump head support. **I**
13. Reinstall tube housing cover and screws.

FINAL INSTALLATION

1. Inspect the suction and discharge lines, point of injection, and check valve for blockages. Clean and/or replace as required. Failure to do so may lead to poor pump performance, including shortened tube life.
2. Reconnect the suction and discharge lines.
3. Prime pump and verify operation.
4. Place pump in desired operating mode.

CLEANING THE POINT OF INJECTION – SAFETY INFORMATION

 **NOTICE:** Indicates special instructions or general mandatory action.

 **NOTICE:** Pumps are supplied with an injection fitting or check valve. All allow the extension tip to be installed in the center of the pipe directly in the flow of water to help reduce deposit accumulation.

 **WARNING** Warns about hazards that **CAN** cause death, serious personal injury, or property damage if ignored.

 This is the safety alert symbol. When displayed in this manual or on the equipment, look for one of the following signal words alerting you to the potential for personal injury or property damage.

 **WARNING** HAZARDOUS PRESSURE/CHEMICAL EXPOSURE:

 Use caution and bleed off all resident system pressure prior to attempting service or installation.

 Use caution when disconnecting discharge line from pump. Discharge line may be under pressure. Discharge line may contain chemical.

 To reduce risk of exposure, the use of proper personal protective equipment is mandatory when working on or near chemical metering pumps.

CLEANING THE POINT OF INJECTION continued

1. Turn metering pump off and unplug cord. Disable any water pump or auxiliary equipment's electrical supply.
2. Depressurize system and bleed pressure from pump discharge line.
3. Loosen and remove the 3/8" or 1/4" nut & ferrule from the check valve or injection fitting to disconnect discharge line.

Duckbill Check Valve or Ball Check Valve

- Unscrew the top fitting (check valve body) to disassemble. The bottom fitting (injection fitting with arrow) should remain attached to the pipe.
 - Remove duckbill or remove ball check components from check valve body. Inspect and replace parts as needed. If using a ball check valve be careful not to stretch or damage the spring.
4. Insert a #2 Phillips head screwdriver through injection fitting into the pipe to locate or break up accumulated deposits. If screwdriver cannot be inserted, drill the deposit out of the injection fitting. DO NOT drill through the opposite pipe wall.
 5. Replace discharge line if cracked or deteriorated. If the end is clogged, cut off the calcified or blocked section of discharge line.

Injection Fitting (S30 - 25 psi max.)

Replace ferrule and reinstall the discharge line to the injection fitting approximately 3/4"-1" until it stops.

Duckbill Check Valve or Ball Check Valve

- Reassemble the check valve.
 - Replace ferrule and reinstall the discharge line to the injection check valve approximately 3/4" until it stops.
6. Tighten the connecting nut finger tight while firmly holding the tube fitting. The 3/8" nut may be wrench tightened one additional half turn. If leak occurs, gradually tighten the 3/8" nut as required.
 7. Enable the water pump electrical supply and pressurize the water system.
NOTE: The roller assembly must be expanded so the tube is pressed against the tube housing wall.
 8. Put the metering pump back in service and inspect all connections for leaks.

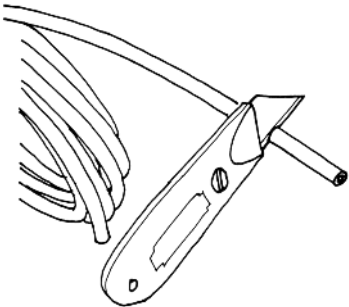

Cut off the calcified or blocked section.

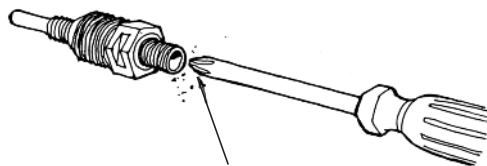

Clean out accumulated deposits with a #2 Phillips head screwdriver.

Periodic inspection and cleaning of the point of injection will maintain proper pump operation and provide maximum tube life.

PUMP HEADS

S30 Pump Heads

25 psi (1.7 bar) max. Includes pump head with tube, ferrules 1/4" or Europe 6 mm

DESCRIPTION	UM	Insert tube # for □	
		PART NUMBER	Europe 6 mm
S3QP Pump Head with Santoprene® tube #3, 4, 5	EA	S310□-1	S315□-1
	2-PK	S310□-2	S315□-2
S3QP Pump Head with Versilon® tube #3, 4, 5	EA	S320□-1	S325□-1

100 psi (6.9 bar) max. Includes pump head with tube, ferrules 1/4" or Europe 6 mm

DESCRIPTION	UM	Insert tube # for □	
		PART NUMBER	Europe 6 mm
S3QP Pump Head with Santoprene® tube #1, 2, 7 & duckbill	EA	S310□-1	S315□-1
	2-PK	S310□-2	S315□-2
S3QP Pump Head with Versilon® tube #1, 2 & Pellethane® duckbill	EA	S320□-1	S325□-1

S40 Pump Heads

25 psi (1.7 bar) max. Includes pump head with tube

DESCRIPTION	UM	PART NUMBER
S4 Pump Head with Santoprene® tube #5X	EA	S41B5X-1
	2-PK	S41B5X-2

100 psi (6.9 bar) max. Includes pump head with tube

DESCRIPTION	UM	PART NUMBER
S4 Pump Head with Santoprene® tube #7X	EA	S41B7X-1
	2-PK	S41B7X-2

S50 Pump Heads

25 psi (1.7 bar) max. Includes pump head with tube

DESCRIPTION	UM	PART NUMBER
S5 Pump Head with Santoprene® tube #5G	EA	S5105G-1
	2-PK	S5105G-2

100 psi (6.9 bar) max. Includes pump head with tube

DESCRIPTION	UM	PART NUMBER
S5 Pump Head with Santoprene® tube #7G	EA	S5107G-1
	2-PK	S5107G-2

NOTE: Confirm material compatibility with the chemical resistance guide in the catalog.

Refer to the Flow Rate Outputs chart to match the pump with the correct tube.

PUMP HEAD PARTS

S30 Pump Head Parts

DESCRIPTION	UM	PART NUMBER
S3QP Tube Housing with Latches	EA	S3400-1
	2-PK	S3400-2
S3QP Roller Assembly	EA	S3500-1
	4-PK	S3500-4
S3QP Tube Housing Cover	EA	S3600-1
	4-PK	S3600-4
Latches, plastic	2-PK	QP401-2

S40 Pump Head Parts

DESCRIPTION	UM	PART NUMBER
S4 Tube Housing	EA	S44B0-1
	2-PK	S44B0-4
S4 Roller Assembly	EA	S45B0-1
	4-PK	S45B0-4
S4 Tube Housing Cover	EA	S46B0-1
	4-PK	S46B0-4
S4 Pump Head Support	EA	S40B3-1

S50 Pump Head Parts

DESCRIPTION	UM	PART NUMBER
S5 Tube Housing	EA	S5400-1
	2-PK	S5400-2
S5 Roller Assembly	EA	S5500-1
	4-PK	S5500-4
S5 Tube Housing Cover	EA	S5600-1
	4-PK	S5600-4
S5 Pump Head Support	EA	S5003-1

S40, S50 Pump Head Parts

DESCRIPTION	UM	PART NUMBER
Transition Sleeve	EA	S5002-1
Thumbscrews	4-PK	S5001-4
Tube Pull	EA	S6063-1

PUMP HEAD SERVICE KITS

Pump Head Service Kit Contents	
QP, S3QP	Tube, Roller Assembly, Nuts, Ferrules, Latches, (Duckbill where noted)
S4, S5	Tube, Roller Assembly, Nuts, Thumbscrews, Support

S30 Pump Head Service Kits

25 psi (1.7 bar) max.

DESCRIPTION	UM	Insert tube # for □	
		PART NUMBER	Europe 6 mm
S3QP Pump Head Service Kit with Santoprene® tube #3, 4, 5	KIT	S310□K	S311□K
S3QP Pump Head Service Kit with Versilon® tube #3, 4, 5	KIT	S320□K	S321□K

100 psi (6.9 bar) max.

DESCRIPTION	UM	Insert tube # for □	
		PART NUMBER	Europe 6 mm
S3QP Pump Head Service Kit with Santoprene® tube & duckbill #1, 2, 7	KIT	S310□K	S311□K
S3QP Pump Head Service Kit with Versilon® tube & Pellethane® duckbill #1, 2	KIT	S320□K	S321□K

S40 Pump Head Service Kits

25 psi (1.7 bar) max.

DESCRIPTION	UM	PART NUMBER
S4 Pump Head Service Kit with Santoprene® tube #5X	KIT	S41B5XK

100 psi (6.9 bar) max.

DESCRIPTION	UM	PART NUMBER
S4 Pump Head Service Kit with Santoprene® tube #7X	KIT	S41B7XK

S50 Pump Head Service Kits

25 psi (1.7 bar) max.

DESCRIPTION	UM	PART NUMBER
S5 Pump Head Service Kit with Santoprene® tube #5G	KIT	S5105GK

100 psi (6.9 bar) max.

DESCRIPTION	UM	PART NUMBER
S5 Pump Head Service Kit with Santoprene® tube #7G	KIT	S5107GK

NOTE: Confirm material compatibility with the chemical resistance guide in the catalog.

Refer to the Flow Rate Outputs chart to match the pump with the correct tube.

PUMP TUBES

S30 Tubes

Includes ferrules 1/4" or Europe 6 mm

DESCRIPTION	UM	Insert tube # for □	
		PART NUMBER	Europe 6 mm
#1, 2, 3, 4 or 5 Santoprene® tube	2-PK	UCCP20□	UCCP2□CE
	5-PK	MCCP20□	MCCP2□CE
#7 Santoprene® tube	2-PK	UCCP207	UCCP27CE
	5-PK	MCCP207	MCCP27CE
#1, 2, 3, 4 or 5 for Versilon® tube	2-PK	UCTYG0□	UCTY□CE
	5-PK	MCTYG0□	MCTY□CE

Includes duckbill, ferrules 1/4" or Europe 6 mm

DESCRIPTION	UM	Insert tube # for □	
		PART NUMBER	Europe 6 mm
#1 or 2 Santoprene® tube & duckbill	2-PK	UCCP□FD	UC□FDCE
#7 Santoprene® tube & duckbill	2-PK	UCCP7FD	UC7FDCE
#1 or 2 for Versilon® tube Pellethane® duckbill	2-PK	UCTY□FD	UCTY□DCE

S40 Tubes

DESCRIPTION	UM	PART NUMBER
#5X Santoprene® tube	2-PK	S4005X-2
	5-PK	S4005X-5
#7X Santoprene® tube	2-PK	S4007X-2
	5-PK	S4007X-5

S50 Tubes

DESCRIPTION	UM	PART NUMBER
#5G Santoprene® tube	2-PK	S5005G-2
	5-PK	S5005G-5
#7G Santoprene® tube	2-PK	S5007G-2
	5-PK	S5007G-5

Refer to the Flow Rate Outputs chart to match the pump with the correct tube.

CHECK VALVES AND MODBUS KIT

S30 Duckbill Check Valves

100 psi (6.9 bar) max.

DESCRIPTION	UM	PART NUMBER	Europe 6 mm
1/4" or 6 mm Duckbill Check Valve with nut, ferrule, Santoprene® duckbill	EA	UCDBINJ	UCINJCE
	5-PK	MCDBINJ	MCINJCE
1/4" or 6 mm Duckbill Check Valve with nut, ferrule, Pellethane® duckbill	EA	UCTYINJ	UCTINJCE
	5-PK	MCTYINJ	MCTINJCE
3/8" Duckbill Check Valve with nut, Santoprene® duckbill	EA	UCINJ38	
	5-PK	MCINJ38	
3/8" Duckbill Check Valve with nut, Pellethane® duckbill	EA	UCTYIJ38	
	5-PK	MCTYIJ38	

S40, S50 Ball Check Valves

100 psi (6.9 bar) max.

DESCRIPTION	UM	PART NUMBER
3/8" Ball Check Valve with nut, tantalum spring, FKM seat & O-ring	EA	BC038-1
3/8" Ball Check Valve with nut, stainless steel spring, EPDM seat & Santoprene® O-ring	EA	BC238-1

Modbus Kit

Applies to S Series pump FW 3.02.02 or higher

DESCRIPTION	UM	NO. DE PARTE
Manual, Modbus RS-485 communication cable, 3 terminal, liquid tight junction	KIT	MOD100

WALL MOUNTING BRACKET DIMENSIONS

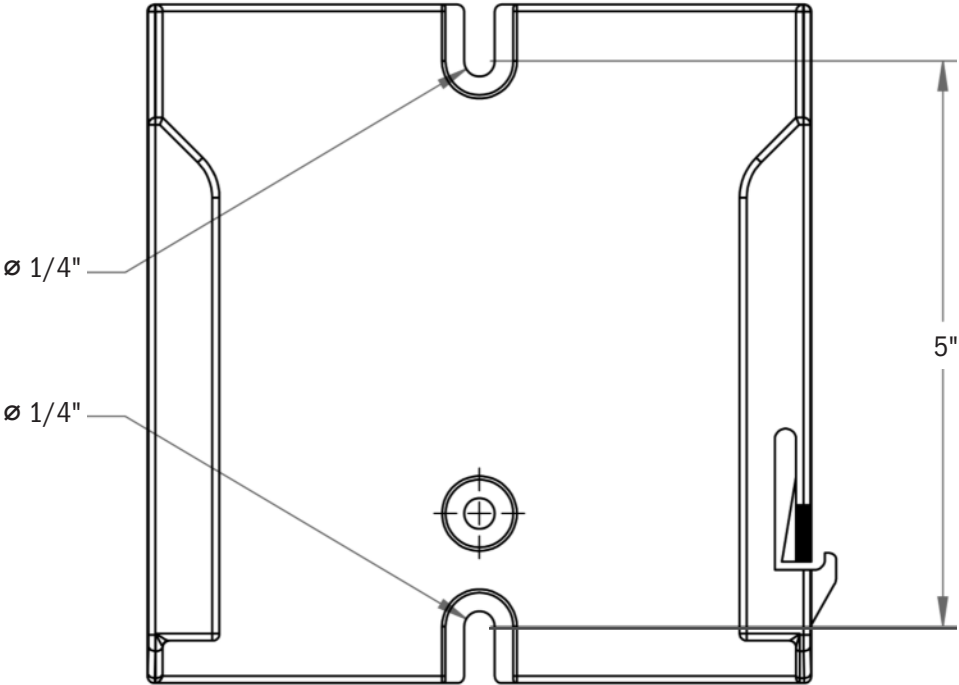

NOTICE: Leave 8" of clearance above pump to allow for removal from mounting bracket.



STENNER PUMP COMPANY

3174 DeSalvo Road
Jacksonville, Florida 32246 USA

Phone: 904.641.1666
US Toll Free: 800.683.2378
Fax: 904.642.1012

sales@stenner.com
www.stenner.com

Hours (EST)
Mon.-Fri. 7:00 am-8:00 pm

 Assembled in the USA
with US and international components

© Stenner Pump Company
All Rights Reserved